

Cobolt o6-o1 Series

Plug and play | Modulatable | CW lasers

375 nm	457 nm	553 nm	675 nm	808 nm
395 nm	473 nm	561 nm	685 nm	830 nm
405 nm	488 nm	594 nm	690 nm	850 nm
415 nm	505 nm	633 nm	705 nm	915 nm
425 nm	515 nm	638 nm	730 nm	940 nm
445 nm	520 nm	647 nm	750 nm	975 nm
450 nm	532 nm	660 nm	785 nm	1060 nm

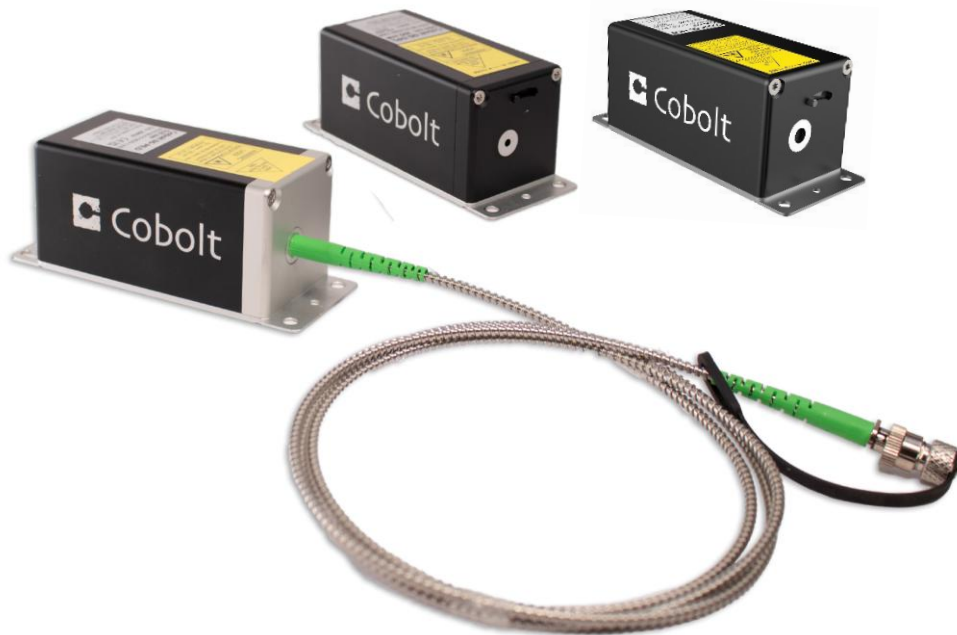

CONTENTS

1.	Introduction	5
2.	Safety	6
2.1.	Symbols in the manual	6
2.2.	General	6
2.3.	Accessible Emission	7
2.4.	Safety features	9
2.5.	Equipment Safety	10
2.1.	Warning and Identification Labels	11
3.	Quick Start Guide	13
3.1.	Mounting and connecting the laser	13
3.2.	Shutting down the laser	14
3.3.	Controlling Emission	15
3.4.	Modulation Quick Start	17
4.	Operation via data port	20
4.1.	Data port connections	20
4.2.	Remote Interface Configuration	20
4.3.	Cobolt Monitor Software	21
4.4.	Command Syntax	24
4.5.	Command list	25
4.6.	Command Descriptions	27
5.	Hardware overview	32
5.1.	Model number	32
5.2.	Configurations	33
5.3.	Laser head	34
5.4.	Key control box	34
5.5.	Thermal management	35
5.6.	Power supply requirements	35
6.	System Specifications	36
6.1.	Optical specifications – o6-MLD and o6-DPL	36
6.2.	Optical Specifications – o6-HPLD	38
6.3.	Operation and Environmental Specifications	38
6.4.	Modulation specifications	39
6.5.	Mechanical Specifications	39
6.6.	Electrical interfaces	41
7.	System states and run mode descriptions	45
7.1.	Autostart program and startup states	45
7.2.	Laser Run Modes and Settings	46
7.3.	Fault descriptions	50
8.	Troubleshooting	51
9.	Warranty and Maintenance	53
10.	Service	53
11.	Disclaimer	53
12.	Compliance (CDRH models only)	54

1. Introduction

The Cobolt o6-01 Series consists of high-performance fixed wavelength laser modules: modulated laser diodes (MLD), modulated diode pumped lasers (DPL) and high-power laser diodes (HPLD) across the spectral range of 375 nm and 1064 nm, with complete yellow-green coverage including 532 nm, 553 nm, 561 nm and 594 nm. All lasers in the Cobolt o6-01 Series share a uniform, compact form factor in a plug and play format with user-friendly software controls. The lasers feature optimum beam quality, and stable, reliable performance.

Designed to support a diverse set of application requirements, the tailored modulation controls of the Cobolt o6-01 Series lasers offer actively-stabilized power control for exceptional pulse-to-pulse stability, with smooth, gentle, and highly linear control of the power across the complete power range, as well as precision high speed modulation with complete dark states during the OFF intervals.

The Cobolt o6-01 Series lasers are manufactured in Sweden utilizing Cobolt's unique HTCure™ Technology to ensure world-class quality, reliability, and unmatched robustness. They are packaged in an easy-to-integrate, industry-standard footprint with all control electronics fully integrated. They can also be supplied with compact, robust fiber delivery option in the o6-x3 configurations.

The Cobolt o6-01 Series lasers are intended for stand-alone use in laboratory environments or integration in analytical instruments. See section 6.1 for available wavelength and power combinations.

The information provided in this manual describes our standard products for research and OEM use. Cobolt specializes in providing high volume custom products and we invite you to contact us for more information and to discuss your needs.

2. Safety

2.1. Symbols in the manual



WARNING – LASER RADIATION This symbol is used to call attention to important laser safety information



CAUTION – GENERAL This symbol is used to call attention to important general operator and equipment safety information



NOTICE – GENERAL This symbol is used to call attention to best practices when using the equipment and does not indicate a hazard.

2.2. General

Cobolt o6-01 Series MLD and DPL lasers are Class IIIB (CDRH), Class 3B (IEC) laser products emitting less than 500 mW of laser radiation within the ultraviolet (UV), visible (VIS) and near Infrared (NIR) spectrum. The residual at wavelengths not specified on the warning label does not exceed Laser Class 1.

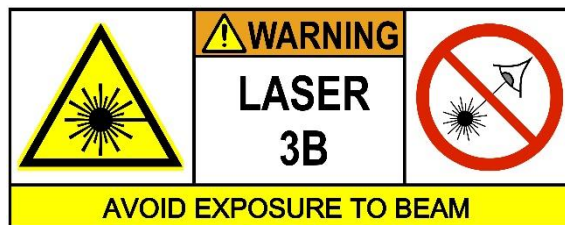

Cobolt o6-01 Series HPLD lasers are Class IV (CDRH), Class 4 (IEC) laser products that emit laser radiation within the ultraviolet (UV), visible (VIS) and near Infrared (NIR) spectrum. The residual at wavelengths not specified on the warning label does not exceed Laser Class 1.



Eye and skin exposure to direct or reflected laser light is hazardous and may be extremely harmful. Always wear eye protection appropriate to the beam wavelength and intensity. Lasers may pose a risk of igniting flammable materials and in event of ignition gasses and fumes may be generated. All equipment used in close proximity to the laser beam should be suitably fire resistant and the facility should be properly ventilated. It is advised to perform a risk assessment for the facility and equipment prior to using the laser. In the case of integration into a larger system, laser safety compliance must be evaluated in the end product. The device must be handled by skilled personnel experienced with lasers, in a laboratory environment and with

access to adequate laser safety equipment. If the equipment is used in a manner not specified in this manual, the protection provided by the equipment may be impaired.

The laser head clearly displays a yellow warning label that shows the location of the laser beam aperture. This label must be visible unless the laser beam is totally enclosed.



CAUTION Use of controls or adjustments or performance of any procedures other than those specified herein may result in exposure to hazardous radiation.

2.3. Accessible Emission

The table below describes the irradiance in W/cm² and appropriate level of eye protection in terms of optical density (OD) for each laser product.



CAUTION Always wear the appropriate eye protection for all the specified emitted wavelengths. Verify the accessible emission wavelengths and power levels on the warning label before operating.

o6-MLD Accessible Emission

Product	Nominal Power (mW)	Nominal Irradiance (W/cm ²)*	Minimum eye protection Requirement** (OD)
Cobolt o6-MLD 375	70	27	5
Cobolt o6-MLD 395	120	47	5
Cobolt o6-MLD 405	150	58	4
	365	142	5
Cobolt o6-MLD 415	120	47	4
Cobolt o6-MLD 425	120	47	4
Cobolt o6-MLD 445	100	39	4
	400	156	5
Cobolt o6-MLD 457	100	39	4
	400	156	4
Cobolt o6-MLD 473	100	39	4
	300	117	4
Cobolt o6-MLD 488	60	23	3
	200	78	4
	300	117	4
Cobolt o6-MLD 505	80	31	3
Cobolt o6-MLD 515	80	31	3
	150	58	3
Cobolt o6-MLD 520	80	31	3
Cobolt o6-MLD 633	80	31	3
Cobolt o6-MLD 638	180	70	3
Cobolt o6-MLD 647	130	51	3
Cobolt o6-MLD 660	100	39	3

Cobolt o6-MLD 685	40	16	3
Cobolt o6-MLD 690	200	78	3
Cobolt o6-MLD 705	30	12	3
Cobolt o6-MLD 730	50	19	3
Cobolt o6-MLD 785	250	97	3
Cobolt o6-MLD 808	120	47	3
Cobolt o6-MLD 830	250	97	3
Cobolt o6-MLD 850	50	19	3
Cobolt o6-MLD 915	250	97	3
Cobolt o6-MLD 940	250	97	3
Cobolt o6-MLD 975	250	97	3
Cobolt o6-MLD 1060	200	78	3

o6-DPL Accessible Emission

Product	Nominal Power (mW)	Nominal Irradiance (W/cm ²)*	Minimum eye protection Requirement** (OD)
Cobolt o6-DPL 532	400	141	4
Cobolt o6-DPL 553	50	18	4
Cobolt o6-DPL 561	200	71	4
Cobolt o6-DPL 594	100	35	4

o6-HPLD Accessible Emission

Product	Nominal Power (mW)	Nominal Irradiance (W/cm ²)*	Minimum eye protection Requirement** (OD)
Cobolt o6-HPLD 405	900	126	6
Cobolt o6-HPLD 425	1200	168	6
Cobolt o6-HPLD 450	1200	168	6
Cobolt o6-HPLD 488	1200	168	6
Cobolt o6-HPLD 520	800	112	5
Cobolt o6-HPLD 638	1200	168	5
Cobolt o6-HPLD 750	1200	168	5
Cobolt o6-HPLD 830	900	126	5
Cobolt o6-HPLD 975	900	126	4

* Irradiance (W/cm²) = 110% of Nominal Power (W) ÷ Beam Area at bottom tolerance (cm²)

** Eye protection (OD) = Log₁₀(Max Power (W) ÷ 60825⁻¹ Emission Limit: Class 1 (W)), rounded up to the next integer.

2.4. Safety features

The laser is equipped with all required safety features as described in the laser safety standard IEC 60825-1. If any part of the delivered equipment is replaced with a part not supplied by Cobolt or if the equipment is not properly grounded system may not conform to CE / CDRH compliance standards listed in section 12. Disabling any of the safety features invalidates the CE marking and violates the laser safety standard. If the laser does not function, do not attempt to open any of the units, or the warranty will be voided.

Remote Interlock Connector

The remote interlock connector provides an interface for external controls placed apart from other components of the laser product such as a system interlock when installing the laser into a larger system. See section 6.6 for a detailed description of the remote interlock circuit and operation. When the terminals of the connector are open-circuited, emission is interrupted, and no radiation will be accessible. When the terminals are connected the laser is permitted to be operated.

Manual Shutter (Beam Stop)

The laser head is equipped with a manual shutter, which functions as the beam stop, capable of preventing human access to laser radiation. The aperture location and the open and close positions of the shutter are indicated on the top surface of the laser head. For o6-03 fiber pigtailed lasers, the fiber's screw-on dust cap is considered the manual shutter.

Key Switch

All CE/CDRH compliant laser models comes with a key control box which must be connected for the laser to operate. When the key is in the OFF position, the diode is prevented from emitting. The key must be actively turned to the ON position each time the laser is powered on. When the key is removed from the system laser radiation is not accessible. It may be necessary to toggle the key twice, depending on why the laser was stopped. This is implemented as an intentional safeguard after a manual reset.

Laser Radiation Emission Warning

The key control box, which is part of the CDRH compliant models, incorporates LEDs which indicate the status of the Laser. The 'ON' LED is illuminated whenever the device is emitting or could emit light. See section 5.4 for details on the key control box. The emission warning indicators are also visible in the Cobolt Monitor™ software.

Fiber Pigtailed Option

All safety recommendations in section 2 are also valid for the Cobolt o6-01 series fiber pigtailed laser heads. Additionally, heat generated from absorption of laser radiation by particles on the fiber end may increase the probability of ignition hazards in certain environments. Always clean the fiber end before turning on the laser. In systems where the beam is exposed, fiber end must be mounted < 2 m from the emission warning LED on the key control box. It is advised to perform a risk assessment for the facility and equipment prior to using the laser. In the case of integration into a larger system, laser safety compliance must be evaluated in application on the final product.

2.5. Equipment Safety

The system is not intended to be serviced by the user in any way, there is no upkeep, maintenance or cleaning required apart from the fiber care mentioned below.

Back Reflection Sensitivity

Laser light reflected directly back into the laser head causes damage to the laser diode and results in a dramatic decrease in product lifetime. o6-MLD lasers with a wavelength greater than 600 nm are particularly sensitive, exercise extreme caution.

Electrostatic discharge

Always install the laser system to a properly grounded power outlet. Cobolt lasers contain a laser diode which is sensitive to electrostatic discharge (ESD).

Fiber care

It is important to always make sure the fiber end-face is clean before turning the laser on and before connecting the fiber connector in physical contact with another connector. Failure to do so may lead to irreparable damage of the fiber end-face. Do not clean the fiber when the laser is on. We recommend using appropriate equipment for fiber cleaning and inspection.

Proper heatsinking

To ensure highest performance and to prevent overheating, it is necessary to mount the laser head on a suitable heatsink. See section 5.5 Thermal management for more details.

2.1. Warning and Identification Labels

The upper face of the laser head contains a yellow label with laser safety warning and classification information, the wavelength and maximum power of the unit. It also shows the location of the laser beam aperture and indicates the open and closed positions of the manual shutter. This label must be visible unless the laser beam is totally enclosed. A silver label showing information about the laser model, manufacturer date and location, and the power supply voltage and current, is located on the laser head.

Free beam laser head

Manufacturer Identification Labels

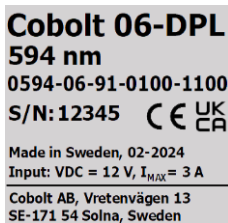

OEM label

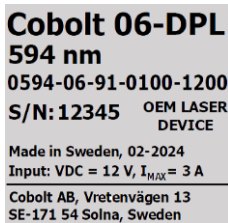

CE /CDRH compliant label



Aperture Warning Labels

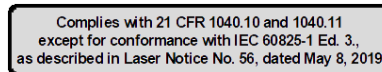
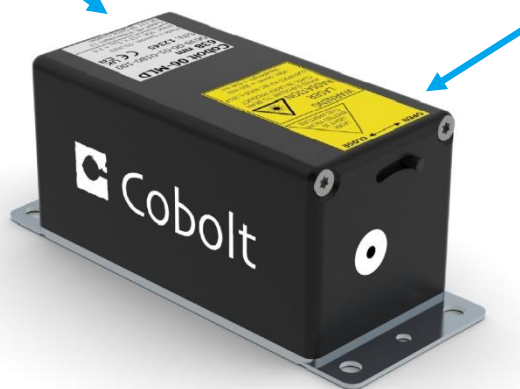

Laser Notice No. 56 Label

CDRH models shipped to USA

Fiber pigtailed laser head

Manufacturer Identification Labels

Cobolt 06-MLD
638 nm
0638-06-03-0080-1200
S/N: 12345 OEM LASER
DEVICE
Made in Sweden, 01-2024
Input: VDC = 12 V, I_{MAX} = 3 A
Cobolt AB, Vretenvägen 13
SE-171 54 Solna, Sweden

OEM Label

Cobolt 06-MLD
638 nm
0638-06-03-0080-1100
S/N: 12345 CE UK
CA
Made in Sweden, 01-2024
Input: VDC = 12 V, I_{MAX} = 3 A
Cobolt AB, Vretenvägen 13
SE-171 54 Solna, Sweden

CE / CDRH compliant label



Aperture Warning Labels

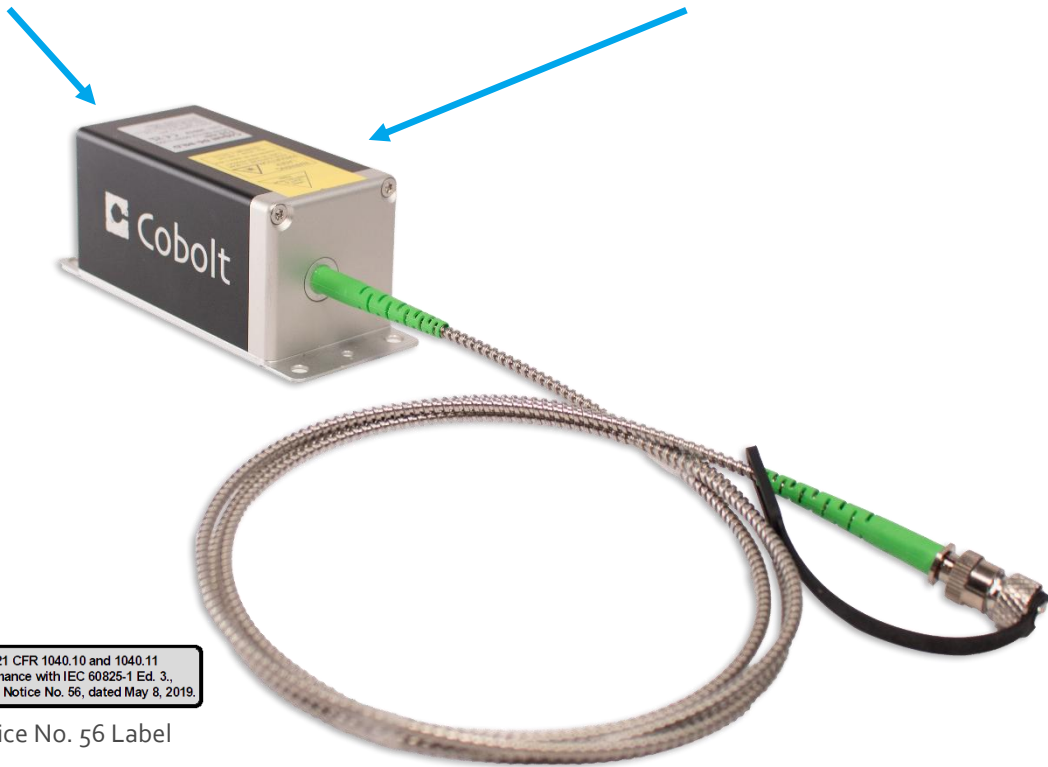

Complies with 21 CFR 1040.10 and 1040.11
except for conformance with IEC 60825-1 Ed. 3.,
as described in Laser Notice No. 56, dated May 8, 2019.

Laser Notice No. 56 Label

CDRH models shipped to USA

3. Quick Start Guide

3.1. Mounting and connecting the laser

1. Mount the laser on a heat sink or suitable flat surface that provides adequate heat dissipation and connection to ground. Use the four holes on the laser's base plate to secure it.



2. Attach the 14-pin Molex cable to CONTROL socket on the laser head.



3. Attach the 15-pin D-SUB cable to the LASER HEAD socket on the key control box.



4. Insert the interlock plug into the connector on the key control box (or verify that it is in place).



5. Connect the supplied 12V power supply unit to the 12V socket on the laser head and plug it in to the mains.



6. To start the laser, turn the key on the Control Box clockwise to the ON position. If it is already in the ON position, turn it to OFF and then ON again. Light will be emitted as soon as the key is turned. The white 'Laser ON' Led will be illuminated.

Key switch



7. The laser will start up in constant power mode at the nominal maximum power level. The system requires up to 3 minutes to stabilize thermally.



NOTICE If the power does not match the power as stated on the test sheet see section 12: Service for more information.

3.2. Shutting down the laser

1. Turn the key switch to OFF first (CDRH models only).
2. Disconnect PSU from mains outlet.
3. Disconnect laser from PSU.
4. Disconnect laser head from Key control box (only required for shipping).

3.3. Controlling Emission

All Cobolt o6-o1 lasers are available with emission controls for continuous wave (CW) or modulation mode operation. In this section the different ways to control the emission of each laser will be introduced. It is not recommended to use the continuous wave emission or power level controls to turn the laser ON and OFF with high speed. For command controls of the functions described in this section see section 4.6 : Command Descriptions. Section 4.3 : Cobolt Monitor Software gives more details about the control software interface.

Laser Run Modes

The lasers are delivered in Constant Power run mode. To prepare the laser for external controls or modulation the user must first select a modulation run mode. In the Power Modulation mode the laser operates with active optical power control during modulation. In the Current Modulation mode the laser operates on current control during modulation. Choose Power modulation mode for the highest level of optical power precision control. Choose Current modulation for highest modulation speeds. Selecting the laser run mode can be done in the Cobolt Monitor™ software, or via the command 'LASer:RUNMode XXX', where XXX is the run mode name : ConstantCurrent, ConstantPower, PowerModulation, or CurrentModulation.

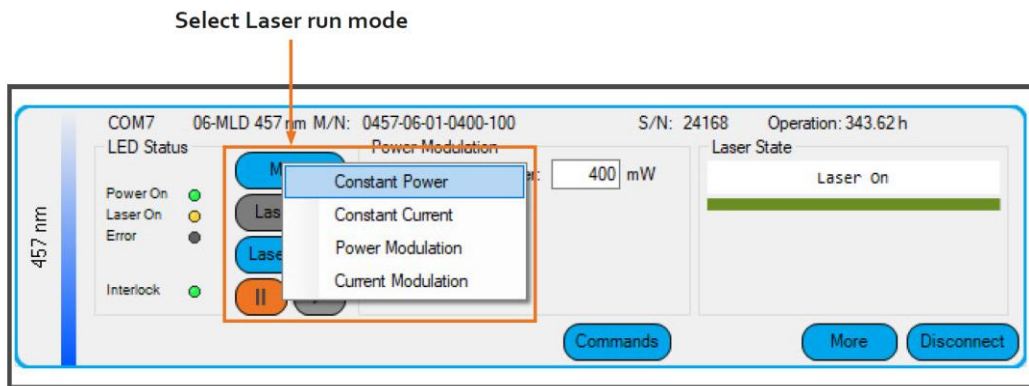

The table below gives a quick reference for choosing the appropriate laser run mode. For more detailed recommendations and information about the intended use of the different laser run modes see section 7 : System states and run mode descriptions and section 3.4 : Modulation Quick Start to continue the modulation mode setup, for information about input signals.

Run mode	o6-MLD	o6-DPL	o6-HPLD
Constant power	DC / Continuous Wave		
Constant current	Trouble shooting and diagnostics		
Power modulation	DC – 10 Hz	DC – 1 kHz	DC – 100 Hz
Current modulation	10 Hz – 150 MHz	1 kHz – 10 kHz	100 Hz – 2 MHz

Laser ON and Laser OFF Button

The Laser ON and Laser OFF buttons can be used to stop and start emission regardless of the laser run mode (constant power, constant current, power modulation or current modulation mode). Access to the Laser ON and Laser OFF buttons is available in the summary level of the user interface as well as the 'More' window. Turning the laser ON and OFF can be done in the Cobolt Monitor™ software, or via the command 'START' and 'STOP'. These functions return the laser to the 'Stand by' state, which requires toggling of the key to resume emission for CDRH compliant systems.

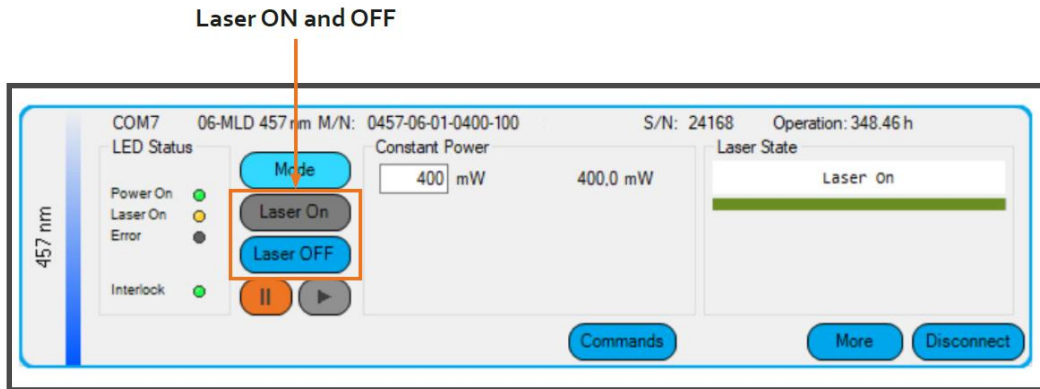

Pause or Resume Emission

Use the pause and play buttons to pause and resume emission. Access to the Pause and Play buttons is available in the summary level of the user interface as well as the 'More' window. Pausing and resuming emission can be done in the Cobolt Monitor™ software, or via the command 'LASer:PAUSed X' where X is 1 for 'Paused' and 0 for 'Un-paused' or 'Resumed'. The laser is considered 'ON' when the emission is paused.

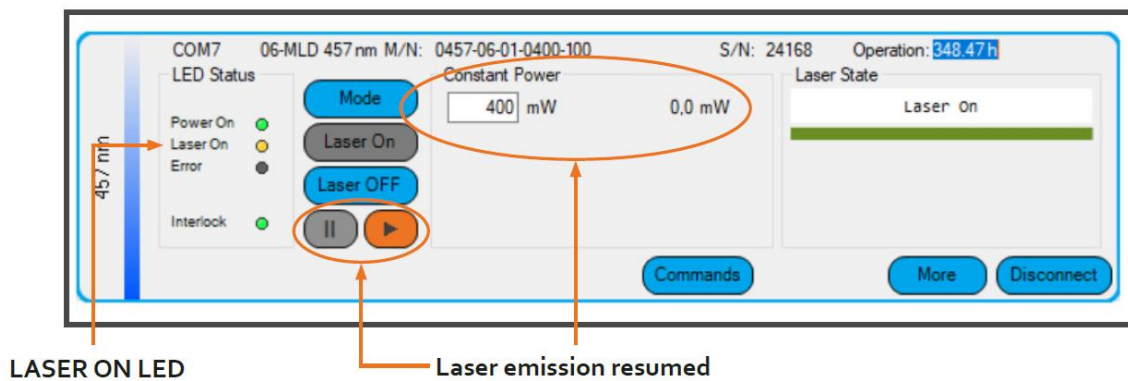

DANGER – Pausing the laser radiation does not make it inaccessible and will not prevent emission in a fail-safe way. Laser ON warning indicators will be illuminated as the lasers are considered armed for operation. Treat the system accordingly and observe all safety precautions.

RESTART and ABORT Button

The 'Restart' button will start the complete autostart sequence including temperature stabilization and warm up. The 'Abort' button cancels the autostart sequence and places the entire device in the 'Aborted' state, the laser is OFF and the temperature controls are not running. The key switch is required to restart the device when in CDRH mode. Aborting and restarting the laser can be done in the Cobolt Monitor™ software, or via the command to the command 'AUTOstart:REStart', the abort button corresponds to the system command 'AUTOstart:ABORT'.

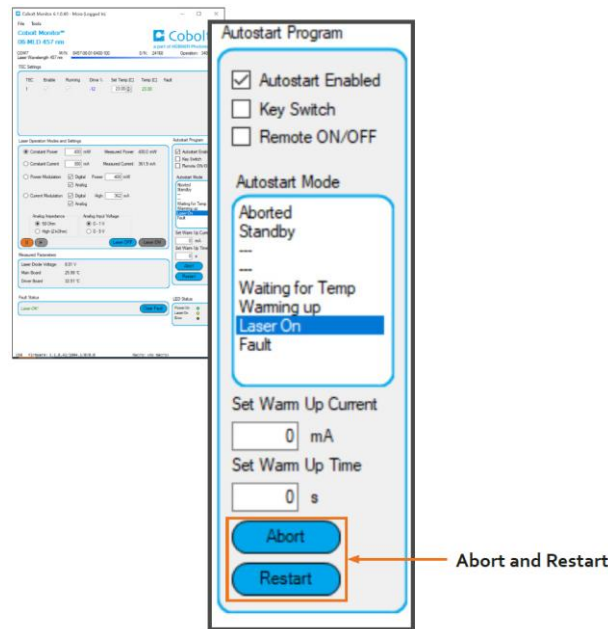

3.4. Modulation Quick Start

Modulation inputs are designed to allow the user to control the laser emission using external signals. Below is a quick reference list for correct modulation inputs for the o6-01 series. In the case of integration into a larger system, when using the laser in modulation mode, the laser safety compliance of the system must be evaluated in the final application. For modulation options without and input signal see the chapter on Command modulation, section 7.2.

Modulation input locations

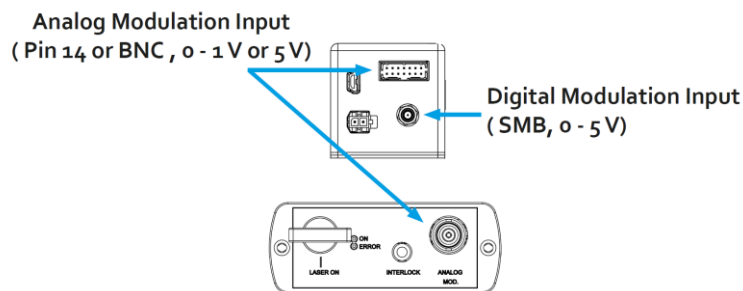

Power modulation

Digital

Modulate the laser ON and OFF to the set power with active power stabilization to ensure a uniform emission within a pulse.

- Modulation Frequency:
 - o6-DPL: DC – 1 kHz
 - o6-MLD: DC – 10 MHz
 - o6-HPLD: DC – 2 MHz
- Input signal: 0 – 5 V TTL signal, square wave
 - 0.0 – 0.8 V: OFF
 - 2.0 – 5.0 V: ON
- Impedance: 2 k Ω

Analog

Use an external voltage to accurately control the laser power, which can also be used in combination with digital modulation. Active measurement of the input voltage ensures precision and linearity of optical response.

- Modulation Frequency:
 - o6-DPL: DC – 1 kHz
 - o6-MLD: DC – 10 Hz
 - o6-HPLD: DC – 100 Hz
- Input signal - programmable:
 - 0 – 1.0 \pm 0.1 V, arbitrary waveform – or –
 - 0 – 5.0 \pm 0.5 V, arbitrary waveform
- Impedance - programmable:
 - 50 Ω – or – 2 k Ω

Mixed digital and analog

Mixed mode modulation is powerful tool to create a pulse that is tailored to the application. In the example below the optical pulse in blue shows the digital ON level being controlled per pulse with an analog signal in magenta, this is intended to demonstrate the precision power control of digital on state via analog voltage. The digital input signal is not shown here.

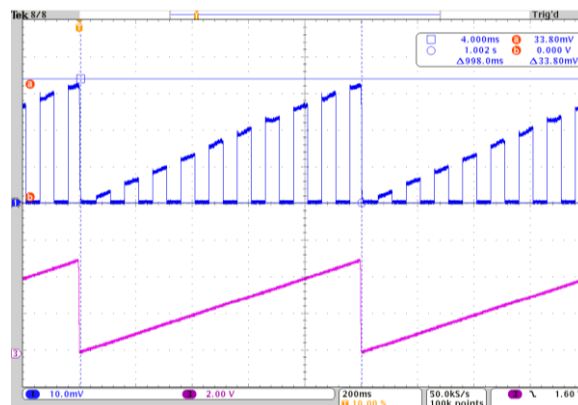

Sample of mixed analog and digital power modulation, 10 Hz digital ON OFF inside a 1 Hz analog voltage ramp.

Current modulation

Digital

High speed ON OFF modulation to a set current level.

- Modulation Frequency:
 - o6-DPL : DC – 10 kHz
 - o6-MLD: DC – 100 MHz
 - o6-HPLD: DC – 2 MHz
- Input signal: 0 – 5 V TTL signal, square wave
 - 0.0 – 0.8 V: OFF
 - 2.0 – 5.0 V: ON
- Impedance: 2 k Ω

Analog

Use an external voltage to actively and directly adjust the laser power.

- Modulation Frequency:
 - o6-DPL: DC – 10 kHz, depending on laser wavelength
 - o6-MLD: DC – 300 kHz
 - o6-HPLD: DC – 2 MHz
- Input signal - programmable:
 - 0 – 1.0 \pm 0.1 V, arbitrary waveform
 - or –
 - 0 – 5.0 \pm 0.5 V, arbitrary waveform
- Impedance - programmable:
 - 50 Ω – or – 2 k Ω

Mixed digital and analog

Mixed mode modulation is power tool to create a pulse that is tailored to the application. In the example below the optical pulse in blue shows the digital ON level is adjusted within a pulse, for example to prevent bleaching of a sample during an exposure. The digital input signal can be seen in cyan and the analog input signal in magenta.

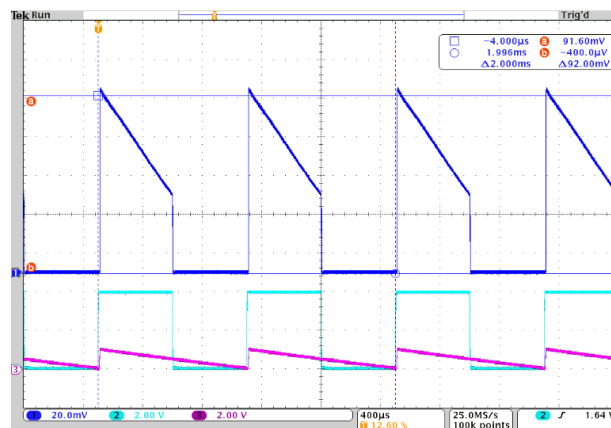

Sample of mixed analog and digital current modulation, a 1 kHz analog voltage ramp inside a 1 kHz digital ON OFF.

4. Operation via data port

4.1. Data port connections

There are three ways to connect a Cobolt o6-01 Series laser to a data port. Avoid communicating via multiple interfaces simultaneously. The data connections are located as follows:

- Mini-USB connection on the laser head for USB communication. The USB cable is provided.
- 9-pin D-SUB connection on the key control box (CDRH model) allows for communication through RS-232
- For OEM Integration the 14-pin Molex connection on the laser head can be used to connect to RS-232 communication. See section 6.6 for the pin assignment. The Molex-RS-232 cable is not standard and is not available from Cobolt.

4.2. Remote Interface Configuration

USB communication

When using a Cobolt laser with Windows 10 or Windows 11, the USB device is automatically detected, and the USB driver installed. The computer will recognize the device as a virtual serial port and assign a COM port.

The USB identification string contains the following information:

- COM Port number
- Cobolt Vendor ID: 0x25DC
- Product ID: 0x03EC = o6-MLD, 0x03ED = o6-DPL, 0x03F3 = o6-HPLD
- Laser serial number

When using the Cobolt laser with a Windows 8 or earlier (e.g Windows 7, Vista, XP) it is necessary to install the Cobolt signed USB driver, please refer to the Hübner Photonics website <https://hubner-photonics.com/>.

RS-232 communication

To communicate with a laser, a PC needs to have a serial port. Alternatively, a RS-232-to-USB converter can be used. The serial port settings are listed below.

Establishing serial port communication

Serial communication can be established with the laser using the following configuration:

- Baud rate: 115200
- No parity
- Termination for commands: CR
- Termination for answers: CR+LF
- Byte size: 8 bits
- 1 stop bit

Once the serial port is opened, the laser will not initiate communication under any circumstances, the laser will only transmit a response to each command. Responses may be a numerical value, a string or the acknowledgment string 'OK'. If the system receives a command that it cannot interpret, it responds with 'Syntax error'.

4.3. Cobolt Monitor Software

The Cobolt Monitor™ software provides a graphical interface to monitor the laser performance and control laser operation. Cobolt Monitor™ has been tested with operating systems Windows XP, Windows Vista, Windows 7, Windows 8 and Windows 10. Microsoft .NET 4.0 is required to run the Cobolt Monitor™ software. Most computers with operating systems Windows XP, Windows Vista, Windows 7 and Windows 8 have this included as standard. When using versions of Windows older than Windows 10, a USB driver may be required.

Installation

Download the latest version of the Cobolt Monitor™ software from <https://hubner-photonics.com/>. The Cobolt Monitor™ software is a stand-alone executable. The executable file is packaged with other files needed to run the program in a .zip file. Save the .zip file to any storage device and extract all files. The folder created after extracting the files can be placed on any storage device and Cobolt Monitor™ can be run from there. All files and folders contained in the .zip file must be present for the program to function properly.

Connecting with Cobolt Monitor™ Software

Once the lasers are connected, each laser will be displayed in the Cobolt Monitor™ Software as shown below. Each laser can be controlled individually in the summary box. Only the most critical information is displayed on this level.

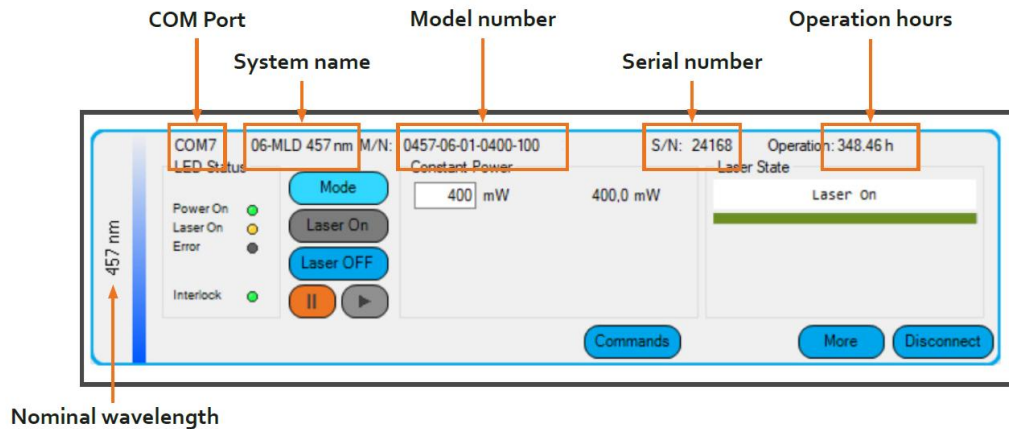

Laser displayed in Cobolt Monitor™.

- COM port** Displays the COM port to which the laser is connected.
- System name** Product description including the model family, o6-MLD, o6-DPL or o6-HPLD, and the nominal wavelength. The system name will be searchable when performing system integration.
- M/N** Displays the laser model number. See section 5.1 : Model number for details.
- S/N** Displays the laser serial number.

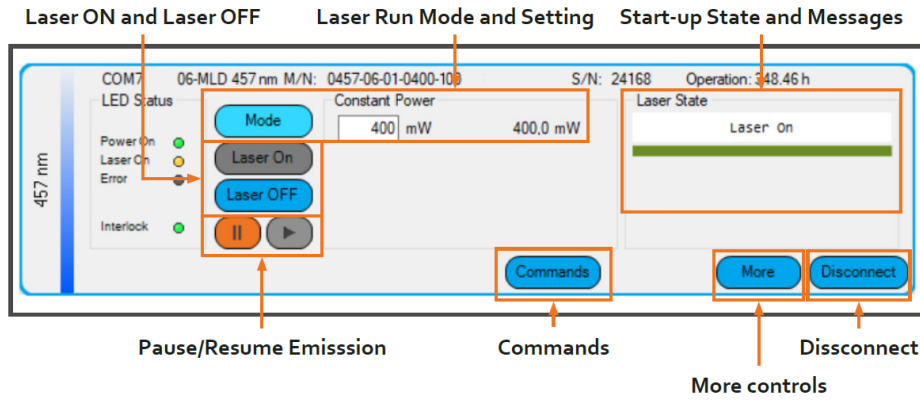

Laser displayed in Cobolt Monitor™.

- Laser ON** Turns the laser ON. If the laser is in autostart mode, this is equivalent to 'Restart'.
- Laser OFF** Turns the laser OFF.
- Pause / Resume** Temporarily pauses emission, laser remains armed and is considered 'ON'.
- Mode** Choose the laser run mode. Click the button to see the drop-down menu and select: Constant Power, Constant Current, Power Modulation or Current Modulation. After selecting the Power modulation or Current modulation run mode, the digital and/or analog modulation can be enabled or disabled via check boxes.
- Commands** Opens a command communications window to send commands directly to the laser.
- Disconnect** Allows the user to disconnect from the Cobolt Monitor™ software in a controlled way.
- More** An additional Cobolt Monitor™ window will open containing more detailed information of that laser's status and operational settings.

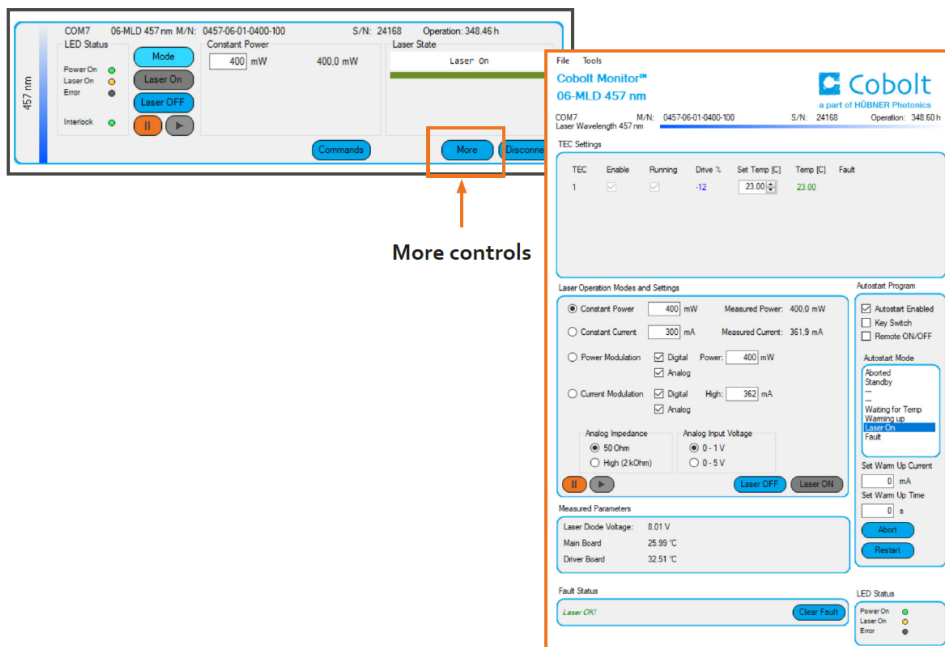

TEC Settings Shows the running status and the fault status for the laser’s internal thermoelectric coolers (TEC). The temperature settings may be different depending on the laser run mode.

Laser Run Mode and Settings

The user can switch between constant power mode, constant current mode, power modulation and current modulation mode. Within the power and current modulation run modes, it is possible to enable and disable the response to analog and digital modulation signals.

Input fields for settings such as the constant power settings and constant current setting, digital power modulation setting and digital current modulation setting. In power modes the current will be set by Cobolt Monitor to reach the power level input into the setting field.

Analog impedance and input voltage

Radio buttons allow the user to choose the appropriate analog impedance and input voltage range for the system. Ensure the signal source is matched to the selected impedance.

Autostart Program

Displays whether the laser is CDRH (key switch enabled) or OEM (key switch disabled) configured and displays the current laser state. There are also buttons to ‘Abort’ the autostart sequence or to ‘Restart’ the laser after a fault.

Fault Status

Displays ERROR messages. In the event of an ERROR, the laser action is stopped. When the reason for the ERROR event is understood and the problem is addressed the fault status can be cleared with ‘Clear Fault’. If the Autostart Program is enabled, click restart to restart the laser.

Clear Fault

Is displayed in the event of a fault. The user can resolve the cause of the fault and then press ‘Clear Fault’ and then restart the laser by clicking ‘Laser ON’. Example: if the remote interlock loop is open the user must make sure the loop is closed again before issuing a ‘Clear Fault’ followed by ‘Laser On’ or clear the fault and restart by toggling the key switch.

LED Status

Displays the LEDs that are currently illuminated on the key control box. The LEDs are displayed in Cobolt Monitor even if the laser is in OEM mode without a key control box.

POWER	Green	Power is supplied.
ON	Orange	Laser emission is possible.
ERROR	Red	An error has occurred.

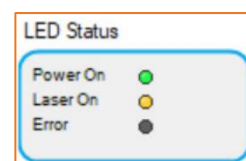

4.4. Command Syntax

The Cobolt laser command syntax listed in this section shows all commands as a mixture of upper- and lower-case letters. The upper-case letters indicate the abbreviated spelling for the command. The commands are not case sensitive. For shorter program lines, the abbreviated form is beneficial whereas the program readability greatly benefits from the long form.

Triangle brackets (< >) indicate that a value must be specified for the enclosed parameter. The square brackets ([]) indicate that part of the command is optional. Query commands must be followed by a question mark '?'. The response for each command is listed in the tables in the next section. If no response is listed, the laser will acknowledge the command with the response string 'OK'.

Arguments of a command must be delimited single space character (ASCII 32). Arguments are not case sensitive but can be abbreviated in the same way as commands.

Examples:

- The command 'LASer:PowerModulation:POWer:SETPoint?' can be abbreviated to : 'LAS:PM:POW:SETP?' or 'las:pm:pow:setp?'
- The command 'TEC2:TEMPerature:reading?' queries the temperature reading of TEC number 2 whereas 'TEC:TEMP?' queries the temperature reading of TEC number 1, the only available TEC for Cobolt o6-MLD lasers.
- 'SYSTEM:INPut:ANALog:VOLTage:RANGe:MAX 5' can be abbreviated to 'syst:inp:ana:volt:rang:max 5'. This is the command that sets the Analog input voltage of the laser to the range 0 – 5 V.

To get started using a Cobolt laser with a program written C++ or Python, please refer to our example codes at the Hübner Photonics GitHub: <https://github.com/cobolt-lasers>.

4.5. Command list

Below is a list of available commands. The name of the command links to the appropriate section with details of the function, arguments and returns. Alternately, browse to the appropriate page for these details.

System Commands	See pg. 27
*IDN?	
SYSTem:MODel:NUMber	
SYSTem:SERial:NUMber	
LASer:HOURs	
AUTOstart:ENabled	
KEYswitch:ENabled	
KEYswitch[:state]	
REMOte:ENabled	
REMOte[:state]	
INTerlock[:state]	
TEC<x>:ENabled	
TEC<x>:TEMPerature:SETPoint	
TEC<x>:TEMPerature[:reading]	
STATe	
SYSTem:INPut:ANALog:IMPedance	
SYSTem:INPut:ANALog:VOLTage:RANGe:MAX	
SYSTem:INPut:ANALog:VOLTage:READING	
FAULt[:name]	
FAULt:STATe	
FAULt:CLEar	
Emission control and laser status	See pg. 28
AUTOstart:REStart	
AUTOstart:ABORt	
STARt	
STOP	
LASer:PAUSed	
LASer:RUNMode	
LASer:POWer[:reading]	
LASer:CURREnt[:reading]	
LASer:CURREnt:SETPoint:MAX	
LASer:POWer:SETPoint:MAX	
LASer:POWer:SETPoint:NOMInal	

Constant power mode	See pg. 29
LASer:ConstantPower:POWer:SETPoint	
Constant current mode	See pg. 29
LASer:ConstantCurrent:CURRent:SETPoint	
Power modulation mode	See pg. 29
LASer:PowerModulation:DIGital:ENabled	
LASer:PowerModulation:ANALog:ENabled	
LASer:PowerModulation:POWer:SETPoint	
LASer:PowerModulation:CURRent:LOW:SETPoint	
LASer:PowerModulation:TEC<x>:TEMPerature:SETPoint	
Power Modulation: Command modulation	See pg. 30
LASer:PowerModulation:DIGital:MODulator	
!e	
!d	
!p	
Current modulation mode	See pg. 30
LASer:CurrentModulation:DIGital:ENabled	
LASer:CurrentModulation:ANALog:ENabled	
LASer:CurrentModulation:CURRent:HIGH:SETPoint	
LASer:CurrentModulation:CURRent:LOW:SETPoint	
LASer:CurrentModulation:TEC<x>:TEMPerature:SETPoint	

4.6. Command Descriptions

Commands to query system information including identification, configuration, state, and fault information.

System Commands

Command description	Argument	Return (data type) [units]
*IDN? Returns an identifier string of the laser	Query Only	(string)
SYSTem:MODEl:NUMber Returns the factory set laser model number.	Query only	(string)
SYSTem:SERial:NUMber Returns the factory set laser model number.	Query only	(string)
LASer:HOURs Returns the number of operation hours of the system.	Query only	(string)
AUTOstart:ENabled Returns the autostart enabled state.	Query only	0 : Disabled 1 : Enabled
KEYswitch:ENabled Returns the key switch enabled state.	Query only	0 : Disabled 1 : Enabled
KEYswitch[:state] Returns the key switch position.	Query only	0 : OFF 1 : ON
REMOte:ENabled Returns the remote ON OFF enabled state.	0 : Disabled 1 : Enabled	0 : Disabled 1 : Enabled
REMOte[:state] Returns the remote ON OFF signal, if 5V is present on the appropriate pin or not	Query only	0 : No input signal 1 : 5 V is present
INTerlock[:state] Returns the interlock circuit state. If the interlock circuit is open or closed.	Query only	0 : Open 1 : Closed
TEC<x>:ENabled Returns the enabled state of TEC x. <x> is either 1 [default], 2, 3	Query only	0 : Disabled 1 : Enabled
TEC<x>:TEMPerature:SETPoint Returns the set point temperature at TEC <x>. <x> is either 1 [default], 2, 3	Query only	(float) [°C]
Command description	Argument	Return (data type) [units]
TEC<x>:TEMPerature[:reading] Returns the measured temperature at TEC <x> <x> is either 1 [default], 2, 3	Query only	(float) [°C]

STATe Returns the state of the laser within the startup sequence. If autostart is not enabled the return will not contain 'autostart_'	Query only	AutostartAborted AutostartStandby AutostartWaitingForKeyOn AutostartWaitingForRemote AutostartWaitingForTecs AutostartWarmingUp AutostartLaserOn Aborted Standby LaserOn Fault
SYSTem:INPut:ANALog:IMPedance Sets / returns the system impedance for the analog input signal.	high : 1 kΩ low : 50 Ω	high : 1 kΩ low : 50 Ω
SYSTem:INPut:ANALog:VOLTage:RANGe:MAX Sets / returns the analog modulation input voltage range.	1 : 0 – 1 V 5 : 0 – 5 V	1 : 0 – 1 V 5 : 0 – 5 V
SYSTem:INPut:ANALog:VOLTage:READIng Returns the actual voltage applied to the analog input.	Query only	(float) [V]
FAULt[:name] Returns the fault description (short version)	Query only	(string)
FAULt:STATe Returns the fault state	Query only	0 : No fault 1 : Fault present
FAULt:CLEar Clears the fault message and allows the laser to be restarted.		

Emission control and laser status

Command description	Argument	Return (data type)
AUTOstart:REStart Restarts the autostart program, through waiting for TECs, warmup and to the completed state.		
AUTOstart:ABORT Aborts the autostart sequence. Stops all function including laser drive current and temperature controls.		
START Starts the autostart sequence and results in laser emission once the 'Laser ON' state is reached, regardless of the autostart enabled state.		
STOP Stops the laser emission and will set the laser in the 'Standby' state		
Command description	Argument	Return (data type)
LASer:PAUSed Pause and resume emission without changing the state or operating mode of the laser, no external signal required.	0 : Resume emission 1 : Pause emission	0 : Emission resumed 1 : Emission paused

LASer:RUNMode Sets / returns the run mode for the laser.	ConstantCurrent ConstantPower PowerModulation CurrentModulation	ConstantCurrent ConstantPower PowerModulation CurrentModulation
LASer:POWer[:reading] Returns the actual laser power. For MLDs this value is calibrated to a look up table of corresponding current settings, and for DPLs it is calibrated to the measured photodiode voltage in constant power mode.	Query only	(float) [mW]
LASer:CURRent[:reading] Returns the measured current delivered to the laser diode.	Query only	(float) [mA]
LASer:CURRent:SETPoint:MAX Returns the factory set maximum current setpoint allowed for the laser.	Query only	(float) [mA]
LASer:POWer:SETPoint:MAX Returns the factory set maximum power setpoint allowed for the laser.	Query only	(float) [mW]
LASer:POWer:SETPoint:NOMInal Returns the factory set nominal laser power.	Query only	(float) [mW]

Constant power mode

Command description	Argument	Return (data type)
LASer:ConstantPower:POWer:SETPoint Sets / Returns the constant current mode set point. The input range is limited at the factory.	(float) mW	(float) mW

Constant current mode

Command description	Argument	Return (data type)
LASer:ConstantCurrent:CURRent:SETPoint Sets / Returns the desired constant current mode set point. The input range is limited at the factory to prevent damage to the laser and/or limit the power for laser safety reasons.	(float) mA	(float) mA

Power modulation mode

Command description	Argument	Return (data type)
LASer:PowerModulation:DIGital:ENABled Sets / returns the digital power modulation enabled state. If enabled, the laser will require a high signal on the appropriate input to emit.	0 : Disabled 1 : Enabled	0 : Disabled 1 : Enabled
Command description	Argument	Return (data type)
LASer:PowerModulation:ANALog:ENABled Sets / returns the analog power modulation enabled state. If enabled, the laser will require a high signal on the appropriate input to emit.	0 : Disabled 1 : Enabled	0 : Disabled 1 : Enabled

LASer:PowerModulation:POWER:SETPoint Sets / returns the ON level power set point for digital power modulation operation.	(float) mA	(float) mA
LASer:PowerModulation:CURRent:LOW:SETPoint Sets / returns the OFF level current set point for digital power modulation operation. This level is factory set to be as high as possible below the laser threshold for best modulation performance.	(float) mA	(float) mA
LASer:PowerModulation:TEC<x>:TEMPerature:SETPoint Sets / returns the TEC <x> set temperature in power modulation mode.	(float) °C	(float) °C

Power Modulation: Command modulation

In power modulation mode it is possible to use commands as the modulator, in place of external modulation signals. In this mode commands are sent from the computer to turn on and off the laser emission, as well as setting the power level of the emission.

Command description	Argument	Return (data type)
LASer:PowerModulation:DIGital:MODulator Sets the active modulation input signal (external TTL or computer commands)	External (default) Command	External (default) Command
!e Activate emission in Command modulation		No response
!d De-activate emission in Command modulation		No response
!p Set power level in digital Command modulation. If analog modulation is enabled, the analog signal will override the digital setpoint set by this command.	(float (mW))	No response

Current modulation mode

Command description	Argument	Return (data type)
LASer:CurrentModulation:DIGital:ENABled Set / returns the digital current modulation enabled state. If enabled, the laser will require a high signal on this channel to emit.	0 : Disabled 1 : Enabled	0 : Disabled 1 : Enabled
Command description	Argument	Return (data type)
LASer:CurrentModulation:ANALog:ENABled Set / returns the analog current modulation enabled state. If enabled, the laser will require a high signal on the appropriate input to emit.	0 : Disabled 1 : Enabled	0 : Disabled 1 : Enabled

<p>LASer:CurrentModulation:CURRent:HIGH:SETPoint Sets / returns the ON level power set point for digital current modulation operation. This level is factory set to give a digital ON at 100 % of nominal power when the digital high signal is applied without attenuation via the analog modulation input.</p>	<p>(float) mA</p>	<p>(float) mA</p>
<p>LASer:CurrentModulation:CURRent:LOW:SETPoint Sets / returns OFF level power set point for digital power modulation operation. This level is factory set to be as high as possible below the laser threshold for best modulation performance.</p>	<p>(float) mA</p>	<p>(float) mA</p>
<p>LASer:CurrentModulation:TEC<x>:TEMPerature:SETPoint Sets / returns the TEC <x> set temperature in power modulation mode.</p>	<p>(float) °C</p>	<p>(float) °C</p>

[↗ back to Command list](#)

5. Hardware overview

Cobolt o6-01 Series laser systems consist of four main parts: the laser head, key control box, cable between laser head and key control box, and the power supply (not shown). Always install the laser system to a properly grounded power outlet.



Cobolt o6-01 laser with CE/CDRH compliant key control box

5.1. Model number

Cobolt o6-01 Series lasers are sold in two configurations: CE/CDRH compliant and OEM, described in section 5.2. The Cobolt o6-HPLD lasers are multiple transversal mode lasers, denoted with an additional –M in the model number.

The model numbers for the o6-Series lasers are composed as described below:

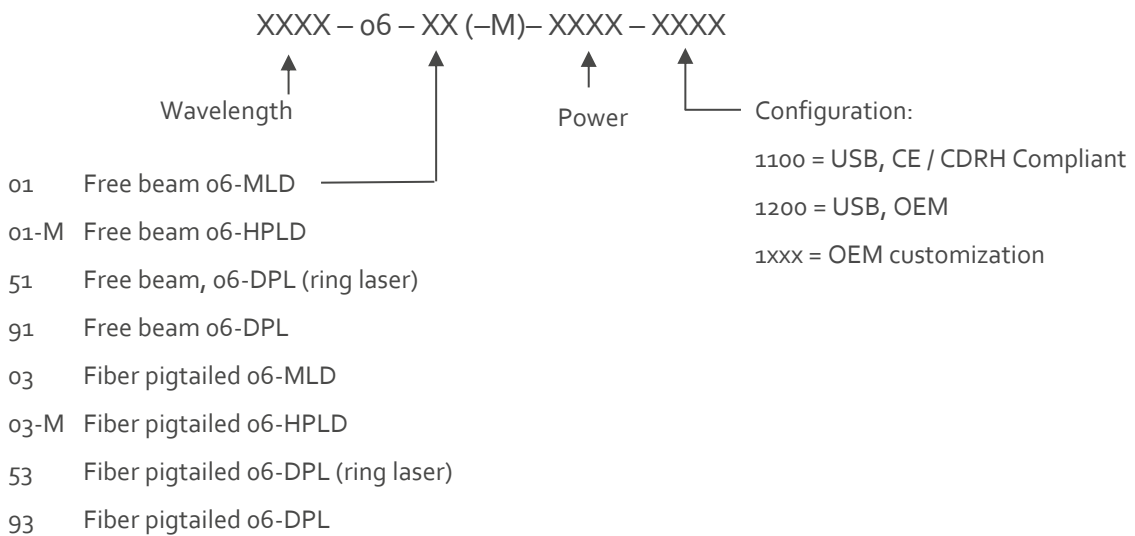

5.2. Configurations

CE/CDRH Compliant

The CE/CDRH compliant system is supplied with a key control box, which must be connected, along with a remote interlock connector. Once power is supplied, laser emission starts when the key is turned from the OFF position to the ON position. The status of the laser can be monitored via LEDs on the key control box. Setting the key to its OFF position puts the laser in stand-by mode, when the laser is in stand-by mode the key must be turned to the ON position to resume emission.

The standard CDRH model consists of:

- Laser head
- Key control box
- Keys
- 12 V power supply unit, including 5.1 mm DC to 2-pin Molex converter.
- Remote interlock plug (for short circuiting the remote interlock connector)
- USB communication cable
- 14 pin Molex to 15-pin D-SUB cable between laser head and key control box

OEM

The laser head is supplied **without** the key control box. Connecting a 12 VDC power supply to the laser head initiates an automatic start-up sequence. If the remote interlock is connected, laser emission will start automatically as soon as power is supplied, and internal temperatures are stabilized.

The OEM model consists of:

- Laser head
- 12 V power supply unit, including 5.1 mm DC to 2-pin Molex converter.
- USB communication cable
- Remote interlock plug (for short circuiting the remote interlock connector)

5.3. Laser head

The laser head contains the laser cavity, beam shaping optics, thermoelectric coolers (TEC) for temperature control and, in o6-DPLs, an optical feed-back loop which ensures long-term power stability of the emitted laser beam. The laser head also features a manual mechanical shutter, a laser hazard label and a laser classification label. When power is supplied to the laser head, regardless of direct on/off or key-switch state, the temperature control element will be active to reach its set point values. The mini-USB is used to communicate with the laser. In addition, the laser head supplies a Molex 14-pin connection, of which the pin 1 and pin 2 are used for the remote interlock function.

o6-01, o6-01-M, o6-51 and o6-91 Free beam lasers

Cobolt model o6-01, o6-01-M, o6-51 and o6-91 are free beam lasers. See section 6.1 for available wavelengths and power levels.

o6-03, o6-03-M, o6-53 and o6-93 Fiber pigtailed lasers

Cobolt version o6-03, o6-03-M, o6-53 and o6-93 lasers models are delivered with a permanently aligned fiber pigtail. The fiber is equipped with a removable output ferrule cover for protection of the fiber end. The fiber output ferrule cover serves as the mechanical shutter of the laser system. See section 6.1 for available wavelengths and power levels.

5.4. Key control box

The optional key control box allows the user to operate the laser with a CE/CDRH compliant key-switch. It also provides direct connections for analog modulation. The key control Box has LEDs to indicate the laser status.

The status of the laser is given via LED indicators:

POWER	Green	Power is supplied.
ON	White	Laser is armed. This light is on in modulation mode if laser emission is possible through the application of external signals. If the laser is armed and waiting for temperature stabilization, the indicator will blink.
ERROR	Red	An error has occurred.



5.5. Thermal management

To ensure operation within given specifications and for the warranty to be valid, the laser head must be mounted on a suitable heat sink. The requirement on thermal resistance of the heat sink can be calculated by taking the difference between the maximum allowed laser head base plate temperature (50 °C) and the ambient temperature at the air-heat sink interface (e.g. 40 °C), divided by the maximum power dissipated from the laser; 12 W for o6-MLD and 25 W for o6-DPL. The o6-MLD laser head must be attached to a heat sink providing a thermal resistance of < 0.8 K/W at 40°C ambient temperature and the o6-DPLs require a heat sink with a thermal resistance of < 0.4 K/W. The mounting surface should be flat within 0.05 mm over the mounting surface. Under normal circumstances thermal heat compound is not required, however if the laser is operated in an area with a high ambient temperature it is recommended to use a thermally conductive compound between the laser head and the heat sink to provide good thermal contact. For assistance in thermal management and system integration, please contact the local sales representative, see section 10.

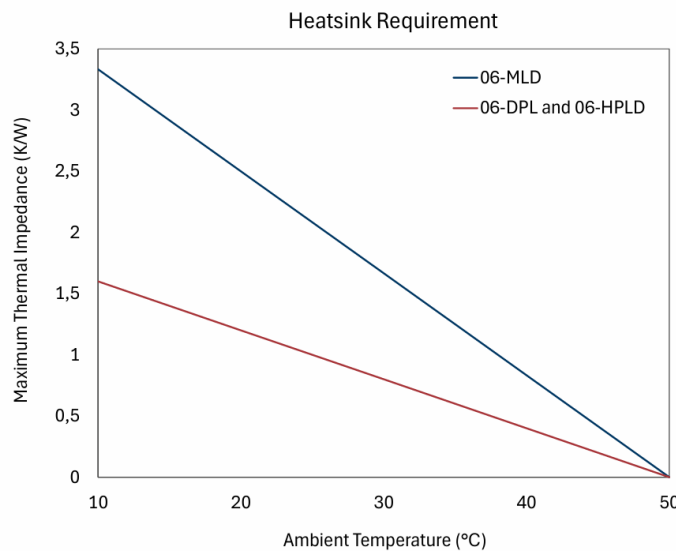

Heat Sink Requirements for Cobolt o6-01 Series.

5.6. Power supply requirements

An appropriate Power Supply Unit (PSU) is supplied by Cobolt with the laser and can be plugged into a standard power outlet. The power supply accepts 90 - 264 VAC and 47-63 Hz. Ripple and noise 1 % peak-peak max. Accepted voltage range for the laser head is (12.0 ± 0.4) VDC. Specification values are given at 12 VDC. The maximum current is 3 A (max 36 W).

6. System Specifications

The information presented here is believed to be accurate and is subject to change without notice. The specifications contained herein cannot be guaranteed outside of normal operational conditions.

6.1. Optical specifications – o6-MLD and o6-DPL

Product type	o6-MLD											
Center wavelength (nm)	375 ± 5	395 ± 5	405 ± 5	415 ± 5	425 ± 5	445 ± 5	457 ± 5	473 ± 5	488 ± 3	505 ± 3	515 ± 3	520 ± 5
Spectral bandwidth (FWHM)	< 1.2 nm								< 1.5 nm			
Output Power (mW)	70	120	150 365	120	120	100 400	100 400	100 300	100 200 300*	80	80 150	80
Power stability over 8 hrs (%)	< 1.0											
Noise, 20 Hz – 2 MHz (RMS, %)	< 0.2											
Beam diameter at aperture (µm)	700 ± 100											
Beam symmetry	> 0.90:1											
Beam divergence (full angle, mrad)	< 1.1		< 1.2					< 1.3				
Spatial mode (TEM ₀₀)	M ² < 1.2											
Fiber pigtailed power (mW)	25	25	75 150	60	60	50 200	50 200	50 150	30* 100* 150	40	40 75	50
Power stability over 8 hrs (%)	< 2.0											
Noise, 20 Hz – 2 MHz (RMS, %)	< 0.3											
Fiber exit ferrule	End-cap (red boot)									No end-cap (green boot)		
Fiber Output	FC/APC, Narrow key											
Fiber Type	SM/PM											
Polarisation	PER > 100:1 (>20 dB) ± 3° relative to key, vertical											
MFD (µm)	3.5 ± 0.5								4.0 ± 0.5			
Standard Fiber Length	1 m											
Jacketing	Ø 3mm, stainless steel											
Warranty***	12 mo., 5000 hrs			24 months, unlimited hours								

Product type	o6-DPL				o6-MLD							
Center wavelength (nm)	532.1 ± 0.3	552.8 ± 0.3	561.2 ± 0.3	593.6 ± 0.3	633 ± 3	638 ± 5	642 ± 5	647 -1/+4	660 ± 5	675 ± 5	685 ± 5	
Spectral bandwidth (FWHM)	< 1 MHz				< 1.2 nm							
Output power (mW)	50, 100 200 400	25, 50 100	25, 50 100 200	50 100 150	80	180	180	130	100	200	40	
Power stability over 8 hrs (%)	< 2.0				< 1.0							< 2.0
Noise, 20 Hz – 2 MHz (RMS, %)	< 0.25				< 0.2							< 0.5
Beam diameter at aperture (µm)	700 ± 70				700 ± 100							
Beam symmetry	> 0.95:1				> 0.90:1							
Beam divergence (full angle, mrad)	< 1.2			< 1.4	< 1.6							< 1.75
Spatial mode (TEM ₀₀)	M ² < 1.1				M ² < 1.2							
Fiber pigtailed power (mW)	25, 50 100 200**	25 50	25 50 100	50	50	80	80	60	50	100	20	
Power stability over 8 hrs (%)	< 2.0											
Noise, 20 Hz – 2 MHz (RMS, %)	< 0.3										< 0.6	
Fiber exit ferrule	No end-cap (green boot)											
Fiber Output	FC/APC, Narrow key											
Fiber Type	SM/PM											
Polarisation	PER > 100:1 (>20 dB) ± 3° relative to key, vertical											
MFD (µm)	4.0 ± 0.5				4.5 ± 0.5							
Standard Fiber Length	1 m											
Jacketing	Ø 3mm, stainless steel											
Warranty***	24 months, unlimited hours				24 months or 5000 hours							

Product type	o6-MLD										
Center wavelength (nm)	690 ± 5	705 ± 10	730 ± 5	785 ± 5	808 ± 5	830 ± 5	850 ± 5	915 ± 10	940 ± 10	975 ± 5	1064 ± 10
Spectral bandwidth (FWHM)	< 1.2 nm		< 2 nm								
Output power (mW)	200	30	50	250	120	250	200	250	250	250	200
Power stability over 8 hrs. (%)	< 2.0										
Noise, 20 Hz – 2 MHz (RMS, %)	< 0.2							< 0.5			
Beam divergence, full angle (mrad)	< 1.75	< 1.9	< 2.0	< 2.6	< 2.3	< 2.6				< 3.0	
Beam symmetry	> 0.90:1										
Beam diameter at aperture (µm)	700 ± 100										
Spatial mode (TEM ₀₀)	M ² < 1.2				M ² < 1.3				M ² < 1.4		
Output power (mW)	100	15	20	100	50	100	100	100	100	100	100
Power stability over 8 hrs (%)	< 2.0										
Noise, 20 Hz – 2 MHz (RMS, %)	< 0.3							< 0.6			
Fiber exit ferrule	No end-cap (green boot)										
Fiber Output	FC/APC, Narrow key										
Fiber Type	SM/PM										
Polarisation	PER > 100:1 (>20 dB) ± 3° relative to key, vertical										
MFD (µm)	4.5 ± 0.5				5.5 ± 0.5					6.6 ± 0.5	
Standard Fiber Length	1 m										
Jacketing	Ø 3mm, stainless steel										
Warranty***	24 months or 5000 hours										

* Without end-cap in standard configuration
 ** With end-cap in standard configuration
 *** Warranty covers lasers only, 12 months limited warranty on fiber workmanship

6.2. Optical Specifications – o6-HPLD

Product type	o6-HPLD								
Center wavelength (nm)	405 ± 5	425 ± 5	450 ± 10	488 ± 5	520 ± 10	638 ± 6	750 ± 5	830 ± 10	975 -10/+5
Output Power (mW)	900	1200	1200	1200	800	1200	1200	900	900
Power stability over 8 hrs (%)	< 1.0								
Noise, 20 Hz – 2 MHz (RMS, %)	< 0.2								
Beam diamentions (mm, typ)	X: 2 ± 1 Y: 2 ± 1								
Fiber pigtailed power (mW)	750	1000	1000	1000	650	1000	1000	750	750
Fiber Output	FC/PC, Narrow key								
Fiber Type	Multimode								
Fiber core diameter (µm)	50,105*, 200,400						105*, 200,400		
Standard Fiber Length	1 m								
Jacketing	stainless steel								
Warranty	12 months, 5000 hours								

* Standard fiber core diameter, other core diameters available upon request

6.3. Operation and Environmental Specifications

Product	o6-MLD	o6-DPL	o6-HPLD
Power supply requirements	12 VDC, 3 A		
Intended use environment	Laboratory (indoor), pollution degree 2		
Maximum baseplate temperature	50 °C		
Ambient temperature, operation	10 - 40°C		
Ambient temperature, storage	-10 °C to +60°C		
Humidity	0-90 % RH non-condensing		
Ambient Air pressure	950 - 1050 mbar		
Laser Head heat sink thermal impedance at 40 °C ambient	< 0.8 K/W	< 0.4 K/W	
Maximum heat dissipation of Laser Head	< 25 W		
Warm-up time from complete 'off'	< 3 min		
Communication protocol	USB and RS 232		
Ambient temperature & pointing	< 5 µrad / °C		
Beam position accuracy (mm)	< 0.5		
Beam angle accuracy (mrad)	< 5		

6.4. Modulation specifications

Product	o6-MLD		o6-DPL				o6-HPLD
Nominal Wavelength	375 - 520 nm, 633 - 1064 nm		532	553	561	594	405 - 975 nm
Digital power modulation							
Modulation frequency	DC - 10 MHz		DC - 1 kHz				DC - 2 MHz
Rise/fall time	< 2.5 ns*		< 100 µs				< 50 ns*
Extinction ratio	> 10 000 000 : 1 (>70dB)						
Input signal - Low	0 - 0.8 V						
Input signal - High	2 - 5 V						
Input signal - Impedance	2 kΩ						
Analog power modulation							
Modulation frequency	DC - 10 Hz		DC - 1 kHz				DC - 100 Hz
Rise/fall time	< 10 ms		< 100 µs				< 2 ms
Extinction ratio	> 10 000 000 : 1 (>70dB)						
Input signal	0 - 1 V - or - 0 - 5 V						
Threshold voltage	37 ± 5 mV (0 - 1 V) 68 ± 5 mV (0 - 5 V)		< 0.1 V (0 - 1 V) < 0.5 V (0 - 5 V)				37 ± 5 mV (0 - 1 V) 68 ± 5 mV (0 - 5 V)
Input signal - Impedance	2 kΩ - or - 50 Ω						
Digital current modulation							
Max. modulation frequency	100 MHz	50 kHz	5 kHz	10 kHz	50 kHz	2 MHz	
3 dB bandwidth	150 MHz	100 kHz	10 kHz	50 kHz	100 kHz	---	
Rise/fall time	< 2.5 ns*	< 6 µs	< 60 µs	< 30 µs	< 6 µs	< 50 ns*	
Input signal - Low	0 - 0.8 V						
Input signal - High	2 - 5 V						
Input signal - Impedance	2 kΩ						
Analog current modulation							
3 dB bandwidth	300 kHz	50 kHz	5 kHz	10 kHz	50 kHz	2 MHz	
Rise/fall time	< 2 µs	< 6 µs	< 60 µs	< 30 µs	< 6 µs	< 250 ns	
Input signal	0 - 1 V - or - 0 - 5 V						
Threshold voltage	37 ± 5 mV (0 - 1 V) 68 ± 5 mV (0 - 5 V)						
Input signal - Impedance	2 kΩ - or - 50 Ω						

* Fall time increased to up to 250 ns for IR wavelengths

6.5. Mechanical Specifications

Laser Head dimensions	100 x 40 x 40 mm
Fixation holes, Laser head	∅ = 4 x 4.2 mm; 90 mm x 30 mm
Weight	< 0.3 kg

Mechanical Drawings

6.5.1. Laser Head

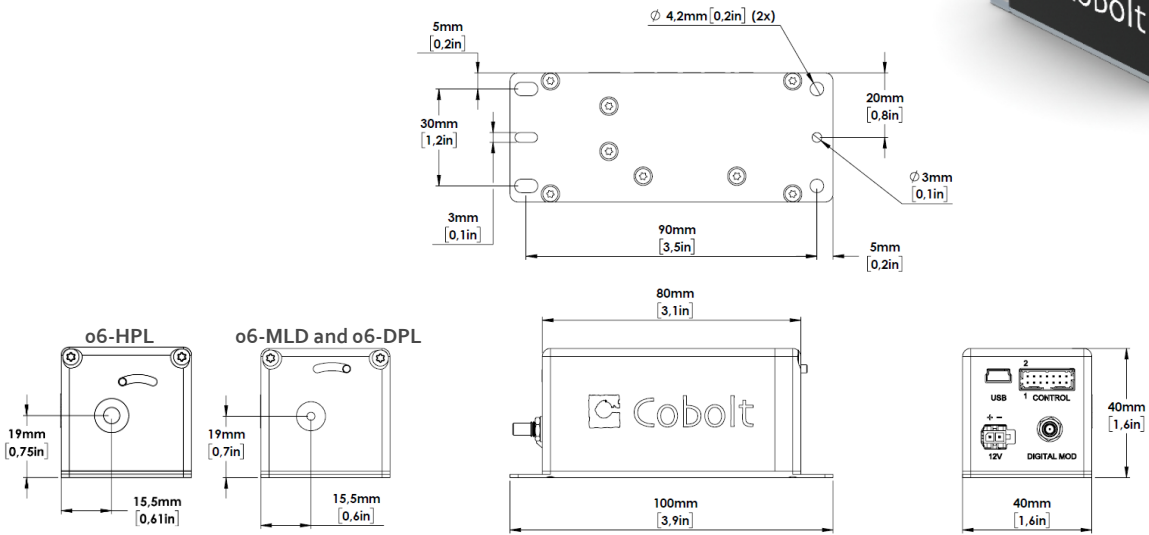
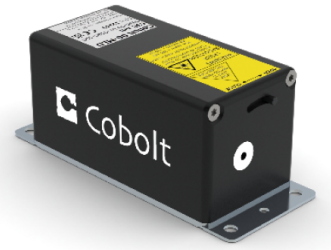

Free beam laser mechanical outline. Dimensions in mm [inches].

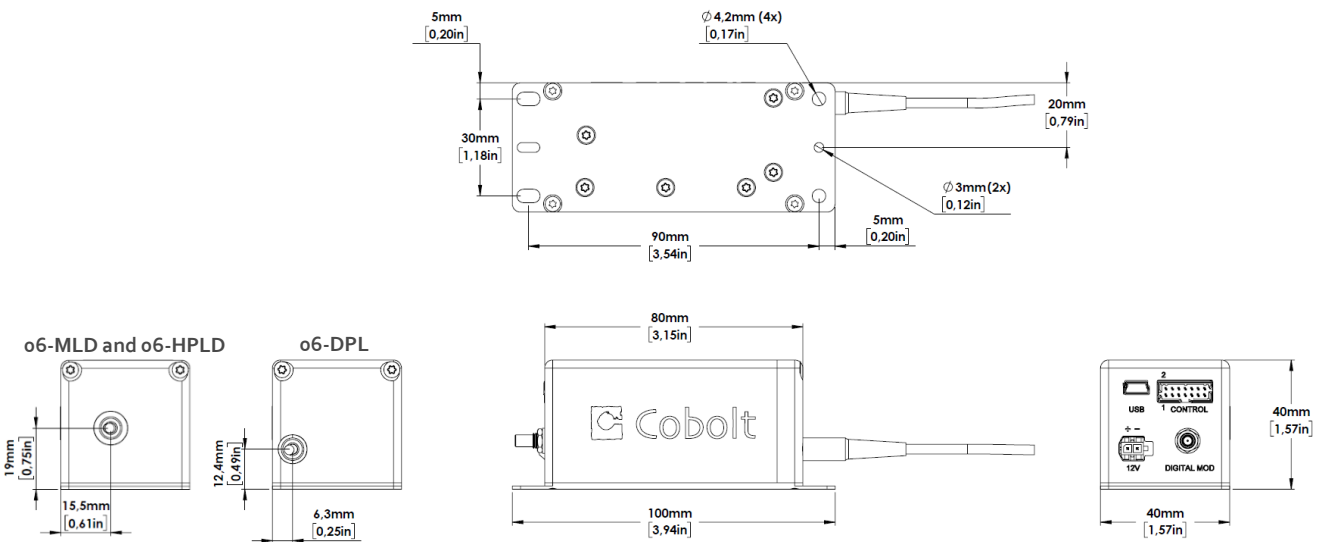

Fiber Pigtailed Laser head mechanical outline. Dimensions in mm [inches].

6.5.2. Key control box (CE/CDRH compliant models only)

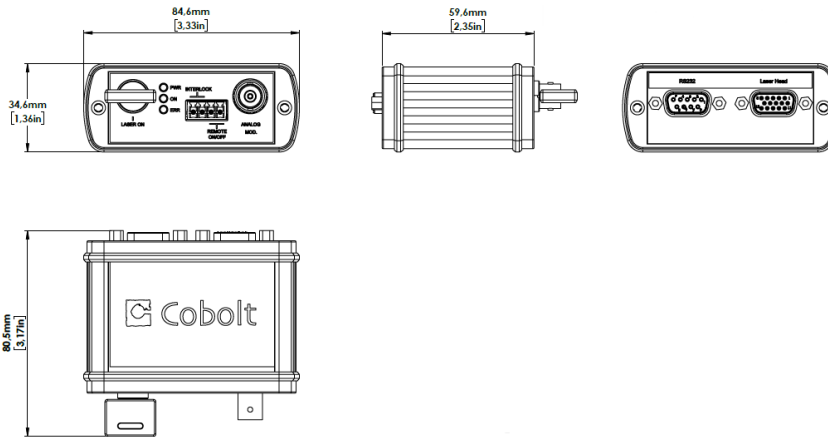

o6-01 Series Key control box, mechanical outline. Dimensions in mm [inches].

6.6. Electrical interfaces

All equipment connected to the system should be limited energy as described by IEC 61010:1.

Interface	Location	Connector description
Input power	Laser Head	2-pin Molex (430450209)
Remote Interlock (OEM)	Laser Head	14-pin Molex; pin 1 & 2 (878331420)
Data port	Laser Head	USB-type mini-B
Key control Box connector	Laser Head	14-pin Molex male (878331420)
Digital modulation	Laser Head	SMB female
Analog modulation (OEM)	Laser Head	14-pin Molex; pin 13 & 14
Laser Head connector	Key control box	VGA D-SUB 15-pin male
Remote Interlock (CDRH)	Key control box	4 pin Würth header (69132210004) ; pin 1 & 2
Remote ON OFF	Key control box	4 pin Würth header (69132210004); pin 3 & 4
Analog modulation (CDRH)	Key control box	BNC female

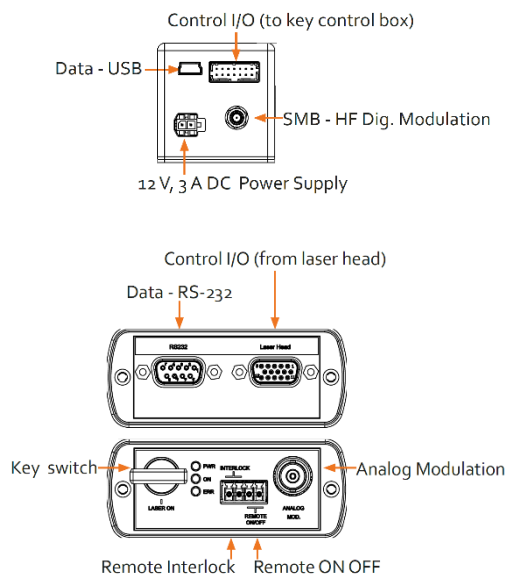

Pin assignment

Power supply connector on laser head

Connector 2 pin Molex (430450209)

Pin	Function
1	+12 V
2	D-

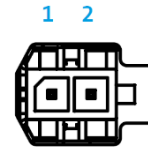

USB connector on laser head

Connector USB-type, mates with connector mini-B.

Pin	Function
1	+5 V
2	D-
3	D+
4	Not connected
5	0 V (GND)

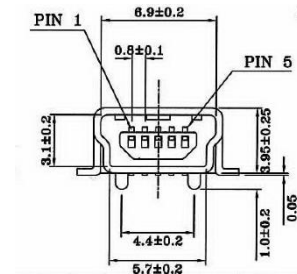

Laser head I/O – alt. to Keybox connector

The pin configuration for the I/O 14-pin Molex on the laser head are described in the table below. For CDRH configured laser heads the key control box cable is connected.

Connector 14 pin Molex (878331420)

Pin	Function
1	Interlock
2	GND
3	GND
4	RS232-TX
5	RS232-RX
6	LED 1 – Laser ON
7	LED 1 – Laser ON (redundant)
8	LED 2 – Error
9	Digital modulation input (< 500 kHz)
10	GND
11	Key switch
12	Remote ON/OFF (+5 V Input)
13	GND
14	Analog modulation input

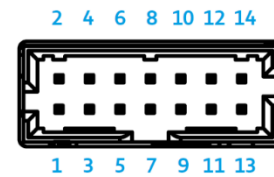

Key box to laser head connector

The pin configuration of the Molex connector on the laser head and the 15-pin D-SUB connector on the key control box is described in the table below.

Connector 15 pin D-SUB

Pin	Function
1	LED 1A – Laser ON
2	LED2 (Error)
3	Analog Modulation Signal
4	0 V GND
5	Key Switch
6	LED 1B – Laser ON (backup)
7	RS232-TX
8	RS232-RX
9	Remote On/Off (+5 V Input)
10	0 V GND
11	Remote interlock
12	<i>Not used</i>
13	0 V GND
14	<i>Not used</i>
15	0 V GND
Shield	0 V GND

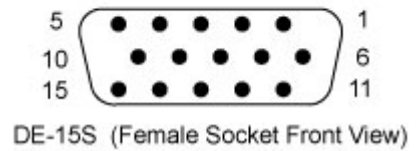
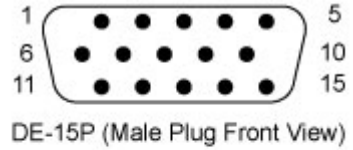

RS-232 on Key box

The pin configuration for the RS-232 socket on the key control box.

Connector 9 pin D-SUB

Pin	Function
1	<i>Not used</i>
2	RS232TX
3	RS232RX
4	<i>Not used</i>
5	0 V GND
6	<i>Not used</i>
7	<i>Not used</i>
8	<i>Not used</i>
9	<i>Not used</i>

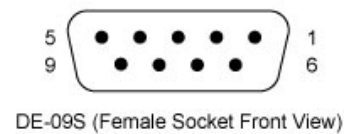
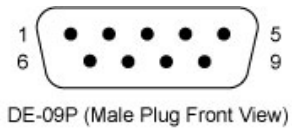

Interlock and Remote interlock

Connector 4 pin Würth header 69132210004

Pin	Function
1	Remote interlock
2	0 V GND
3	Remote On/Off (+5 V Input)
4	0 V GND

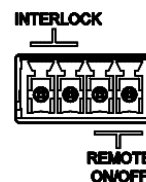

Remote Interlock Connector

The laser is equipped with a remote interlock connector that prevents current flow through the diode when the circuit is open. After the remote interlock connector has been opened the laser will need to be reset by disconnecting from and then reconnecting to the power supply to start up the laser again or toggling the key switch. The signal level is between 0V and + 5V with a pull up resistor, and the current required to ground the remote interlock connector is 5 mA. The time delay in the hardware is < 1 ms, but after filtering by the firmware the reaction time is extended to < 20 ms.

CDRH Configuration

The remote interlock connector is a 2 pin Würth header connected to the 4-pin header on the key control box. The pin 1 and 2 of the header can be connected to short circuit the interlock.

OEM Configuration

In OEM configuration the remote interlock connector is located at pin 1 and 2 of the 14 pin Molex connector on the back of the laser head. To close the remote interlock connector with an external switch, connect to pin 1 and 2 of the Molex plug.

Remote ON OFF control

The Remote ON OFF control feature enables turning the laser ON and OFF using a 5 VDC signal. After having configured the laser for Direct Input operation (factory set or by executing `REMote:ENABLED 1`), the laser can only start-up when 5 VDC (max 12.5 VDC) is applied to pin 12 on the Molex connector with 0 VDC on pin 13 as reference. Remote ON OFF is accessed via pin 3 and 4 on the key control box for CDRH compliant lasers. Shifting the signal to 0 VDC on pin 12 will turn the laser off and put the laser in the 'Waiting for Remote' state. This input only controls the state of the laser and cannot be used to modulate the power output. The remote interlock connection between pin 1 and 2 must also be made.

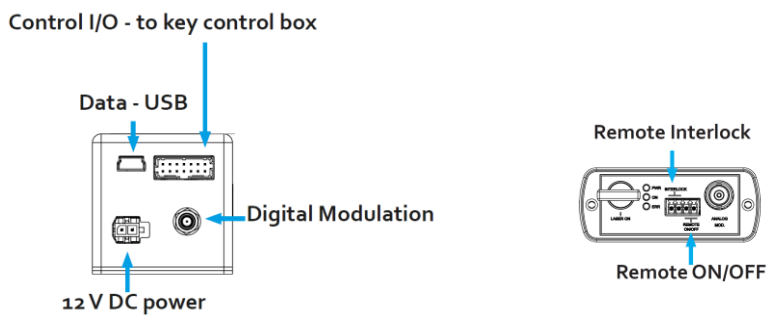

Molex connector on back side of laser head and Würth connector on the key control box.

7. System states and run mode descriptions

Detailed description of the laser start-up states and run modes can be found in this section. This section is intended to provide a deeper knowledge of how the laser works to allow the user to have full understanding and control of the laser operation.

7.1. Autostart program and startup states

All CE/CDRH compliant lasers are delivered with autostart enabled. The descriptions below are specific to the use case where autostart is enabled. If specified by a custom OEM configuration for autostart to be disabled, some descriptions may no longer be valid.

Aborted

The laser enters the 'Aborted' state when the auto-start sequence has been aborted either by the user sending the Abort command or after a fault. While the laser is in the Aborted state laser emission is disallowed and the TECs will not be running. If the laser operation is aborted due to a fault the laser will first go into the Fault state, the fault must be cleared before the laser can proceed to the 'Aborted' state and then be restarted. The laser must be manually restarted with the Cobolt Monitor software, by sending the restart command or by power cycling the system.

Standby

In the 'Standby' state laser emission is OFF. Standby is the first state entered during the auto-start sequence after power is supplied to the system. Standby can be reached intentionally by sending the 'STOP' command. While the laser is in the Standby state the enabled TECs are running, maintaining the lasers internal operating temperatures. The laser can be restarted, or turned ON, with the Cobolt Monitor software, by sending the 'START' command, the 'AUTOstart:REStart' command or by power cycling the system.

Waiting for Key

In the 'Waiting for Key' state the system is waiting for the user to manually toggle the key switch. If the key is in the ON position it is necessary to turn it to the OFF position and back to the ON position before the laser will proceed through the autostart sequence. It may be necessary to toggle the key twice, depending on why the laser was stopped. This is implemented as an intentional safeguard after a manual reset.

Waiting for Remote

The 'Waiting for Remote' state is an optional state available for addition remote emission gating via an external signal. If the Remote ON OFF is enabled, after the key is switched ON the laser proceed to the Waiting for Remote state until the ON signal is provided. See section 6.6 for more information on the required input signals.

Waiting for Temp

In the 'Waiting for Temp' state the temperature controllers are regulating and have not yet reached their set point temperatures. Once the TECs have all reached the set point, the laser will proceed through the autostart sequence through Warming up to Laser ON. If Autostart is enable, the laser will not start until the set point temperatures are reached. This

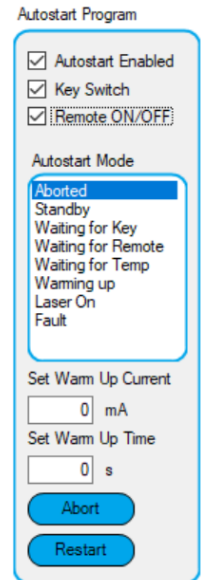

is important for performance as well as equipment safety. If the Autostart is disabled (OEM only) this may be bypassed, but it is never recommended to provide current to the laser before the TECs have reached their set point temperature.

Warming up

Cobolt o6-01 Series lasers are factory set to have no warmup, that is the 'Warm Up Current' is set to 0 mA and the 'Warm Up Time' is set to 0 seconds. Where applicable, the laser provides a fixed current for a fixed number of seconds.

Laser On

In the 'Laser On' state the laser is actively emitting or is armed for emission and can be controlled with the modulation input signal. Even if the modulation signal is low and there is no emission the laser is still considered to be ON.

Fault

The laser is experiencing a fault. The user must address the fault and clear the fault. After clearing the fault, the laser will proceed to the Aborted state (see above). See section 7.3 : Fault descriptions for information on the most common faults.

7.2. Laser Run Modes and Settings

The lasers are delivered in Constant Power run mode. Use this section to get a deeper understanding of each run mode to choose the best run mode and settings within that run mode for the intended application. The laser run modes are exclusive and cannot be used in combination. Analog input impedance and voltage settings are applicable to the analog input signal in both power and current modulation.

The specified performance of Cobolt o6-01 Series is only guaranteed at 100 % of nominal power. The beam size, ellipticity and quality as well as the RMS noise and wavelength may be affected by operating the laser at a current corresponding to a lower power than nominal.

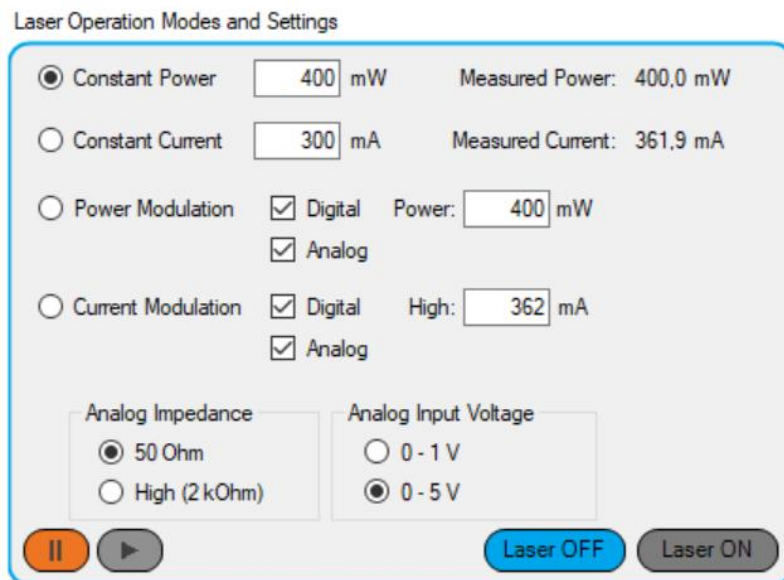

Access to run mode controls in the 'More' window of Cobolt Monitor software

The table below gives a detailed reference to facilitate setup of laser run mode and modulation options. If this is not enough information to support the specific application or interface contact the local Cobolt sales representative for more customized recommendations.

External power control?	Maximum Power control speed?			Digital (ON/OFF) Modulation?	External modulation signal?	Maximum modulation speed?			Laser run mode	Digital?	Analog?	Command?
	o6-MLD	o6-DPL	o6-HPLD			o6-MLD	o6-DPL	o6-HPLD				
No	DC			No	---	---			Constant power	---	---	---
No	500 Hz			Yes	No	500 Hz			Power modulation			<input checked="" type="checkbox"/>
Yes	10 Hz	1 kHz	100 Hz	No	---	---			Power modulation		<input checked="" type="checkbox"/>	
No	DC			Yes	Yes	150 MHz	1 kHz	2 MHz	Power modulation	<input checked="" type="checkbox"/>		
Yes	10 Hz	1 kHz	100 Hz	Yes	Yes	150 MHz	1 kHz	2 MHz	Power modulation	<input checked="" type="checkbox"/>	<input checked="" type="checkbox"/>	
Yes	300 kHz	10 kHz	2 MHz	No	---	---			Current modulation		<input checked="" type="checkbox"/>	
No	DC			Yes	Yes	150 MHz	10 kHz	2 MHz	Current modulation	<input checked="" type="checkbox"/>		
Yes	300 kHz	10 kHz	2 MHz	Yes	Yes	150 MHz	10 kHz	2 MHz	Current modulation	<input checked="" type="checkbox"/>	<input checked="" type="checkbox"/>	

Constant Power

Constant power mode is designed to allow operation of the laser at a fixed output power. The user may input any power setting up to the nominal power. The specified performance of Cobolt o6-o1 Series is only guaranteed at 100 % of nominal power. The beam size, ellipticity and quality as well as the RMS noise and wavelength may be affected by lowering the power.

Cobolt o6-MLDs and Cobolt o6-HPLDs are direct diode lasers and have no active power regulation loop. The power setting is mapped to a specific laser drive current and sets the operating current based on the user input for the desired power.

Cobolt o6-DPLs have an active power regulation loop that steers the laser drive current to maintain a constant output power based on the feedback from a monitor diode inside the laser head.

Constant Current

Constant current mode is designed to allow operation of the laser at a fixed laser current. The user may input any current setting up to the factory set maximum current limit.

Cobolt o6-MLDs and Cobolt o6-HPLDs may be run in constant current mode or constant power mode. The power setting is mapped to a specific laser drive current and displays the power based on the user input for the desired current.

Constant current operation is not recommended for Cobolt o6-DPLs, which have an active power regulation loop that steers the laser drive current to maintain a constant output power based on the feedback from a monitor diode near the end of the beam path.

Power modulation

Power modulation employs active power controls to optimize the ON state power accuracy in digital modulation and the linearity of the optical power to the input voltage in analog modulation.

Digital power modulation

Digital power modulation mode is designed to allow the user to set the digital ON state power via the control software interface. The digital modulation signal can be provided via the SMB digital modulation input or pin 9 on the 'CONTROL' connector. The digital power modulation mode allows the user to set the modulation power level via software or via commands. The laser delivers the correct power based on the factory calibration to a measured output power.

The digital power modulation mode for o6-DPL lasers measures the laser power in a high-speed optical feedback loop to control the ON level power as well as the power stability while ON and ensure uniform pulses up to 1 kHz.

Digital power modulation: Command modulation

Power Modulation run mode in the Cobolt o6-o1 Series can also be utilized to modulate the lasers by software commands in optional combination with external input signals. This part of the run mode is only accessible through software integration and not through the Cobolt Monitor user interface. The Command Modulation is available for modulation of the laser to approximately 500 Hz.

To enable the command modulation, first enter the Power Modulation runmode using the command '**LASer:RUNMode PowerModulation**'. Thereafter, the command modulation can be activated by sending the command '**LASer:PowerModulation:DIGital:MODulator COMmand**'. In the command modulation mode, 3 commands can be used to control the emission of the laser:

- **!e** – Turn on the laser emission
- **!d** – Turn off the laser emission
- **!p XX** – Set the power of the laser emission to XX (mW)

The Command Modulation can be combined with external input signals for both analog and digital control, but enabling the respective input signals, using the commands '**LASer:PowerModulation:ANALog:ENabled 1**' or '**LASer:PowerModulation:DIGita:ENabled 1**'. To exit the Command Modulation send the command '**LASer:PowerModulation:MODulator EXTernal**' to the laser

Analog power modulation

Analog power modulation is designed to provide the user with precision power control via an external input signal with a linear response ($R^2 > 0.99$) between $< 10\%$ and 100% of the selected analog input voltage range, 0-1 V or 0-5V. If using analog modulation in combination with digital modulation, the analog input signal control will override the digital power modulation power setting in the software. The voltage input will determine the ON level of the digital pulses.

Cobolt o6-MLD lasers and Cobolt o6-HPLD lasers actively measure the actual analog input voltage, the laser then determines the correct current level power based on the factory calibration of the laser current to the measured output power. The modulation speed is limited by the refresh rate of the voltage measurement. For high-speed power control or modulation ($> 10\text{ Hz}$ o6-MLD, $> 100\text{ Hz}$ o6-HPLD) the Analog current modulation mode is recommended.

The exact threshold voltage of Cobolt-o6-DPL lasers may vary from laser to laser but is specified to be less than 10% of the selected voltage range due to the power feedback loop. The modulation speed is not limited in the same way as the o6-MLDs and can be used up to 1 kHz .

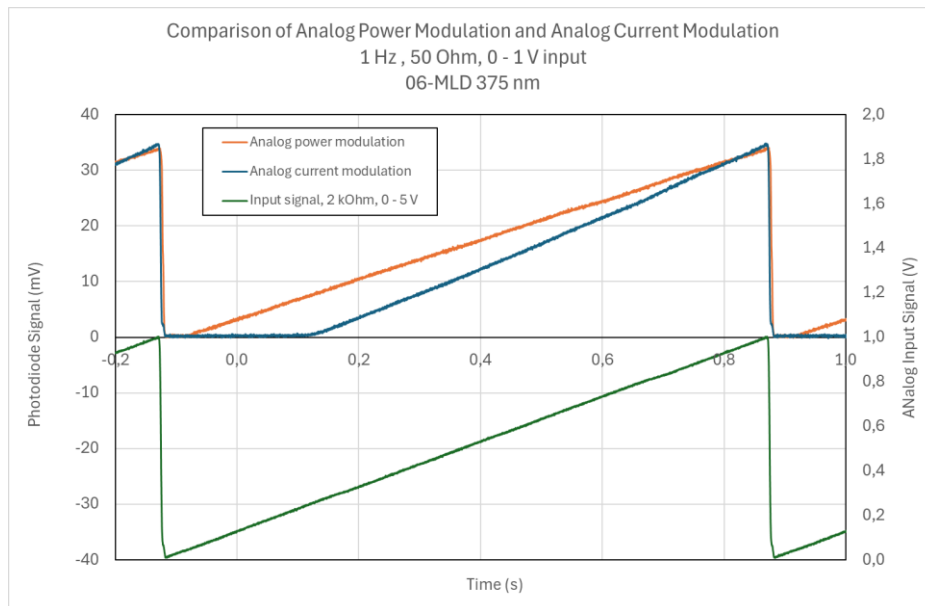

Comparison of the linearity of analog power modulation vs analog current modulation for an o6-MLD laser.

Current modulation

Current modulation is intended for maximum modulation bandwidth, where modulation speed is more important than power accuracy.

Digital current modulation

Digital current modulation mode gives the user access to the full bandwidth, in this mode there is no optical feedback loop so the pulse shape of the o6-DPLs may vary.

The specified maximum modulation frequency is the maximum frequency where the pulse ON is guaranteed to be at least 90% of the nominal power and the OFF state is guaranteed to be less than 10 % of the nominal power.

Analog current modulation

Analog current modulation allows the user to control the laser drive current directly with an analog voltage signal. In addition to the increased modulation speed, the threshold voltage accuracy is more tightly controlled in analog current modulation mode than in analog power modulation mode. If using analog modulation in combination with digital modulation, the analog input signal control will override the digital power modulation power setting. The voltage input will determine the ON level of the digital pulses.

7.3. Fault descriptions

Below is a list of the most common faults the user will encounter.

Fault	Description	Recommended action
InterlockOpen	Laser start failed due to interlock being open	Check the interlock and restart the laser.
NoConvergence	Failed to reach temperature setpoint - not able to stabilize temperature.	The laser's internal temperature regulation is generating a fault.
NoConvergenceLowerRail	Cannot bring temperature down towards setpoint.	
NoConvergenceUpperRail	Cannot bring temperature up towards setpoint.	
NoConvergence	Failed to reach temperature setpoint - not able to stabilize temperature.	Verify the heatsink requirements are met, and that the ambient temperature is within the specified limits.
Overtemperature	A temperature reading exceeds the allowed limit. Use 'fault:description?' should provide details	

8. Troubleshooting

No laser emission 3 minutes after start-up

1. Verify the remote interlock connector is connected and restart the laser.
2. Verify that autostart is enabled. Click the restart button in the Monitor software or send the command 'Restart' to force a restart of the laser.
3. Ensure the laser has adequate heat sinking.
4. Verify the power supply voltage is within the range stated in section 5.6.
5. Check the base plate temperature (this is displayed in the Cobolt Monitor™ software). If it is outside of the range 20-50 °C the laser may take longer to stabilize the temperature or be unable to do so.
6. Remove all modulation inputs and make sure the laser is in constant power mode (in the software or with the 'LASer:RUNMode ConstantPower' command) then restart the laser.
7. Send the command 'FAULT:DESCRiption?' and use the instructions in section 7.3 to address the fault.
8. Contact the local sales representative.

Interlock fault

1. If using a custom interlock system, connect the Cobolt-supplied remote interlock connector plug to check whether the interlock is correctly wired.
2. This remote interlock connector should be connected as described in section 6.6.
3. In the software, check that 'Interlock Open' is not displayed. Send the command 'INTERlock:STATe?' to confirm the Remote interlock connector is not connected (returns a 0 if open).
4. If it is verified that the remote Interlock connector circuit is closed yet an interlock fault is returned, contact the local sales representative.

Laser emission stops.

1. Ensure the laser has adequate heat sinking.
2. Check that the mechanical shutter is open.
3. Ensure all modulation inputs are disconnected, and the laser is in constant power mode at nominal power.
4. Check the base plate temperature (this is displayed in the Cobolt Monitor™ software). If it is outside of the range 20-50 °C the laser may take longer to stabilize the temperature or be unable to do so.
5. Check that the Remote Interlock Connector is connected.
6. Send the command 'FAULT:DESCRiption?'
7. If there is a non convergence fault returned, check that the heat sink is adequate, and that the ambient temperature is under 40°C.
8. If interlock fault is returned, see interlock fault checklist.
9. If the issue persists, contact the local sales representative.

Low power

1. Check that the laser is in constant power mode (using the GUI or the 'Laser:RUNMode ConstantPower' command).
2. Check the power reading using the GUI or the 'LASer:POWer:reading?' command.
3. Remove any connector from the modulation inputs socket on the key control box then restart the laser.
4. Send the command 'FAULt:STATe?' and 'FAULt:STATe' to evaluate the if there is a fault.
5. If the issue persists, contact the local sales representative.

9. Warranty and Maintenance

The Cobolt lasers should not be opened for any reason. The warranty will be void if any of the system units are opened. All laser parameters are set at the factory, and there are no adjustments required (other than those described in this manual for operating in different modulation modes and at different power levels).

Cobolt provides a system warranty according to the specification in section 6, and may depend on the wavelength and power level. The laser systems are designed for modular replacement or repair if the laser head or key control box malfunctions. The fiber pigtailed option has a 12 month limited warranty on fiber related workmanship. The warranty is invalid if the laser system is operated outside of the specific limits and conditions as outlined in this document.

10. Service

Due to accuracy tolerances, calibration differences and allowed power drift there may be discrepancies between the Cobolt measurement of the optical output power and the customer measurement equipment. If the output power deviates from the reported value, please contact the local Cobolt representative for an online re-calibration. The system requires no hardware service or maintenance at all in the field. If there is any performance deviation that cannot be resolved with the control software, the unit is recalled to the factory. If the laser does not function, do not attempt to open any part of the laser system, or the warranty will be voided. Call or e-mail the local Cobolt representative for consultancy and to request an RMA number (see back cover for contact information). If an RMA number is issued and the laser needs to be shipped back to Cobolt or the local representative, please pack the complete system for shipment using the original package or equivalent. Ensure the unit is free from thermal paste before packing. The warranty covers repair or replacing the unit at the option of Cobolt.

11. Disclaimer

Cobolt will assume no responsibility for damage incurred by faulty customer equipment, such as measurement equipment, cables etc., used in conjunction with Cobolt lasers. Cobolt makes no warranty of any kind with regard to the information contained in this guide, included but not limited to, implied warranties of merchantability and suitability for a particular purpose. Cobolt shall not be liable for errors contained herein nor for incidental or consequential damages from the furnishing of this information. No part in this manual may be copied, reproduced, recorded, transmitted, or translated without the express written permission by Cobolt.

12. Compliance (CDRH models only)

The CDRH model lasers (-1100) are designed and manufactured to comply with the EC Low Voltage Directive and the EC EMC Directive in the CDRH-compliant configuration of laser head, key control box, key and Cobolt-supplied power supply. All equipment must be mounted on a common ground plane, such as an optical table. If any part of the delivered equipment is replaced with a part not supplied by Cobolt or if the equipment is not properly grounded, the system may not conform to CE / CDRH compliance standards listed here. Disabling any of the safety features nullifies the CE marking and violates the laser safety standard.



The following harmonized and limits standards have been applied:

Electrical Safety	EN 61010-1, IEC-61010-1, UL 61010-1 (Limited Energy System) UK S.I. 2016 No. 1101 : The Electrical Equipment (Safety) Regulations 2016
Laser Safety/Class	EN 60825-1 FDA / CDRH : Complies with 21 CFR 1040.10 and 1040.11 except for conformance with IEC 60825-1 Ed. 3., as described in Laser Notice No. 56, dated May 8, 2019.
EMC	EN 61326-1 EN 55011 Electromagnetic Emission , Class A Electromagnetic Immunity – Table 2 Requirements EN 61000-4-2 Electrostatic Discharge ±4 kV contact discharge and ±2 kV, ±4 kV, ±8 kV air discharge EN 61000-4-3 Radiated electromagnetic fields 80 – 1000 MHz, 10 V/m with 80 % AM @ 1 kHz 1.4 – 2.7 GHz, 3 V/m with 80 % AM @ 1 kHz EN 61000-4-4 Fast transient / Burst AC Power input port ±2,0 kV EN 61000-4-5 Surge AC Power input port ±0,5 kV, ±1,0 kV, ±2,0 kV Com. Mode AC Power input port, ±0,5 kV, ±1,0 kV Diff. Mode EN 61000-4-6 Conducted Immunity 3 V with 80 % AM @ 1 kHz EN 61000-4-11 Dips and Interruptions 50 Hz and 60 Hz. Test voltages: 100 V and 230 V UK S.I. 2016 No. 1091 : Electromagnetic Compatibility Regulations 2016 FCC 47 CFR - Part 15 (2009): Subpart B, Class A
RoHS	EU Directive 2011/65/EU, EU 2015/863 and amendment EU 2017/2102 UK S.I. 2012 No. 3032

Contact the local sales representative for a copy of the full and up to date Declaration of Conformity.

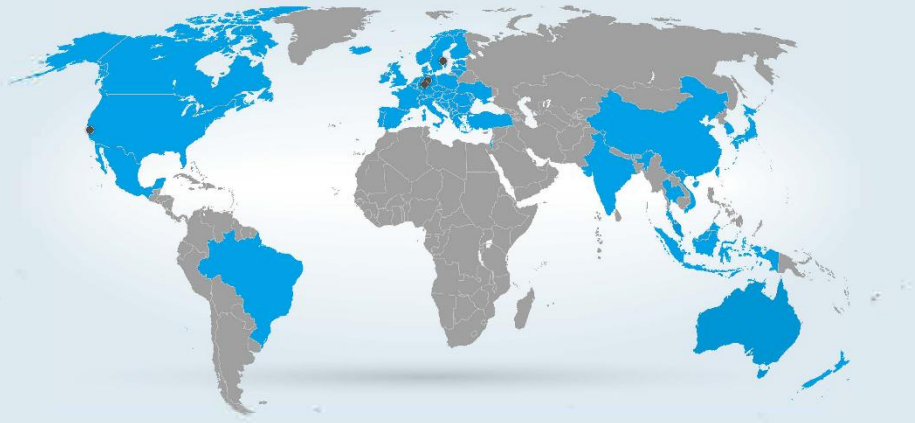

Our Locations

Cobolt AB

(Sales in Norway, Sweden, Finland and Denmark)

Solna, Sweden

Phone: +46 8 545 912 30

Fax: +46 8 545 912 31

E-mail: info.se@hubner-photronics.com

HÜBNER Photonics GmbH

(Sales in Germany, Switzerland and Austria)

Kassel, Germany

Phone: +49 561 994 060-0

Fax: +49 561 994 060-13

E-mail: info.de@hubner-photronics.com

HÜBNER Photonics Inc.

(Sales in USA, Canada and Mexico)

San Jose, California, USA

Phone: +1 (408) 708 4351

Fax: +1 (408) 490 2774

E-mail: info.usa@hubner-photronics.com

HA Photonics Pty Ltd

(Sales in UK and Ireland)

London, United Kingdom

Phone: +44 7359 440 871

E-mail: info.uk@hubner-photronics.com

hubner-photronics.com

HÜBNER Photonics

